



# **R & G Supply, Inc.**

**2026 PRODUCT  
CATALOG**



**2406 West Eules Boulevard, Eules, Texas 76040**  
**METRO- (817) 540-0381    LOCAL- (817) 354-0381**  
**FAX- (817) 545-3982    TOLL FREE- (800) 284-0416**  
**WEBSITE- [www.randgsupply.com](http://www.randgsupply.com)    E-MAIL- [sales@randgsupply.com](mailto:sales@randgsupply.com)**



# R & G Supply, Inc.

## *PRODUCT CATALOG*

### *"Serving You Best"*

*Thank you for choosing R & G as your supplier!*

R & G Supply, Inc. was incorporated in 1978 and has been family owned and operated since. **We have carefully chosen quality name-brand products that we can offer to you at competitive prices, and our customer service is second to none.** *We will work as hard as we possibly can to earn and keep your valuable business!*



If you are located outside the D/FW Metro area, please use our Toll Free (800) telephone number or e-mail us at [sales@randgsupply.com](mailto:sales@randgsupply.com) to contact our customer service representatives and ensure your satisfaction with every order. They will assist you in any way possible. At R & G, we're still small enough to know you, and big enough to serve you!

#### Our contact information:

**METRO-** (817) 540-0381      **LOCAL-** (817) 354-0381  
**FAX-** (817) 545-3982      **TOLL FREE-** (800) 284-0416  
**WEBSITE-** [www.randgsupply.com](http://www.randgsupply.com)      **E-MAIL-** [sales@randgsupply.com](mailto:sales@randgsupply.com)

### Terms and Conditions of Sale

**Prices:** All prices are subject to change without notice. Prices are good for delivery or customer pick-up and are not negotiable. Please contact us for pricing or see our prices at our website: [www.randgsupply.com](http://www.randgsupply.com)

**Delivery:** All orders are F. O. B. Euless, unless delivered on an R & G truck within regular delivery areas: (Minimum \$500 order per delivery with a delivery fee on scheduled delivery days. Non-scheduled deliveries will require a nominal delivery fee). Common carrier or parcel shipments will be made by an R & G selected carrier unless customer specifies otherwise.

**Terms:** All orders are prepaid (requiring cash, cashier's check, or money order), unless customer has an approved open account. We also accept Visa, Mastercard, Discover, American Express and Paypal. Applications for credit accounts are available upon request and when completed must be accompanied by a personal guaranty and a current financial statement.

**Returns:** We will not accept returns on special orders, discontinued items, non-stock items, items altered or cut down at your request, or damaged items. No returns will be accepted without prior written approval from R & G. Approved returns are subject to a 20% re-stocking charge. Returned merchandise must be in clean and salable condition. We are under no obligation to accept returns.

**Product Shortages/ Damage:** It is the customer's responsibility to inspect material upon delivery. Please check the merchandise received against accompanying invoice. Any shortages must be noted by R & G driver and reported within 48 hours of delivery. If material is damaged by carrier, the damage must be noted upon delivery. Concealed damage must be noted within 3 days of delivery.



# TABLE OF CONTENTS

<b>Doors</b>	<b>EXTERIOR AND INTERIOR DOORS, LOCKSETS AND HARDWARE</b>	<b>Page 3</b>
<b>Windows</b>	<b>ALUMINUM AND VINYL FRAMED WINDOWS, WINDOW PARTS AND ACCESSORIES</b>	<b>Page 15</b>
<b>Interior Refurb Items</b>	<b>FLOOR REPAIR, MINI-BLINDS, MOLDING AND PANELING, INTERIOR LIGHTING AND ELECTRICAL ITEMS, INTERIOR VENTING, AND RANGE HOODS</b>	<b>Page 20</b>
<b>Home Safety</b>	<b>FIRE EXTINGUISHERS, SMOKE ALARMS</b>	<b>Page 26</b>
<b>Plumbing</b>	<b>BATHTUBS, SHOWERS, WALL SURROUNDS AND TRIM, SINKS, TOILET PARTS, PLUMBING FIXTURES, PIPES, FITTINGS AND WATER HEATERS</b>	<b>Page 27</b>
<b>HVAC</b>	<b>AIR CONDITIONERS AND DUCTING, FURNACES, THERMOSTATS AND VENTING SUPPLIES</b>	<b>Page 56</b>
<b>Exterior Refurb Items</b>	<b>EXTERIOR LIGHTING AND FIXTURES, SKIRTING, STEPS AND RAILINGS, VINYL SIDING, UNDERBELLY &amp; ROOF REPAIR ITEMS, AND FIBERGLASS STEPS AND HAND-RAILS</b>	<b>Page 60</b>
<b>Fasteners/ Sealants</b>	<b>CAULKS, CEMENTS, SEALANTS AND FASTENERS</b>	<b>Page 77</b>
<b>Set-Up/ Transport</b>	<b>ANCHORS, TIE-DOWNS, SET-UP AND CLOSE-UP ITEMS, FOUNDATION SYSTEMS, AND TRANSPORT ITEMS</b>	<b>Page 78</b>





# HOW TO MEASURE FOR DOOR CALL SIZES

Doors



The call size is simply the width and height of the stud-to-stud rough opening in the wall where the entire door (including the frame) will be installed.

◀ This rough opening may be hidden from view by your existing door and frame, so here is how you can quickly and easily arrive at a call size without exposing the wall's rough opening ▶

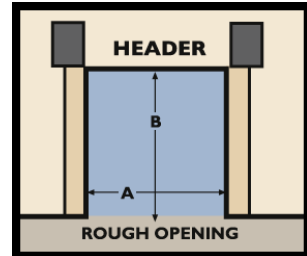

## ▼ For Out-Swing Doors

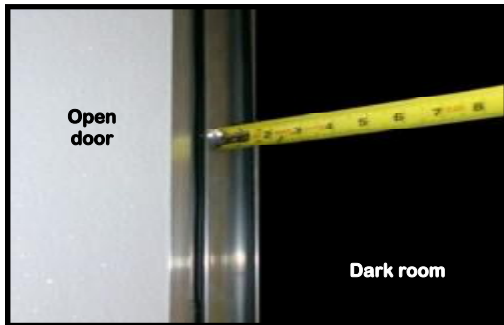

▲ Open your door and measure the inside metal frame from side to side. Round up to nearest even number of inches. The rough opening in the wall is directly right behind this frame.

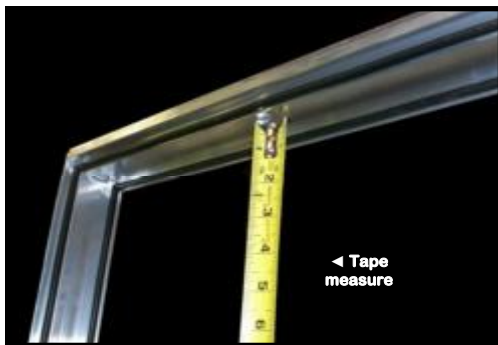

▲ Now measure the inside aluminum frame from header down to the threshold and round up to the nearest even number of inches.

Example: Inside frame measures 33 1/4" x 75 1/4", so the call size is 34 x 76.

To be more certain about determining the call size, measure your existing door as many ways as possible. We will help you cross reference your measurements and determine the call size for your door.

## ▼ For Combination In-Swing Doors, Thermal Doors and Storm Doors



▲ Measure the inside jamb from side to side and round up to nearest even number of inches. This is the space between your storm door and your in-swing door.



▲ Now measure the inside jamb from header down to the threshold and round up to the nearest even number of inches.

### How to Identify Left or Right Hinge:



Look at the door from the outside of the home. The side with the hinges determines left or right hinge.

◀ (Hinges on the left, left-hinge door) (Hinges on the right, right-hinge door) ▶





# SLIDING PATIO DOORS

**"Croft" White Vinyl Framed Sliding Patio Doors with Tempered Low-E Glass**

- 84075-V-XO-** (Left panel opens) ▶
- 84078-XO-** (Left panel opens with argon gas added)
- 84075-V-OX-** (Right panel opens)
- 84078-OX-** (Right panel opens with argon gas added)

\*Made for a 72" wide x 76" tall wall opening (inset measures 71 1/2" x 75 1/2")- **Handle assembly and screen door included-**  
 3/4" Multi-chambered frame provides superior strength-  
 4 7/8" frame depth- Total welded frame and sash construction-  
**Energy efficient 3/4" Intercept glass for optimal thermal performance-** Comes fully assembled and field-reversible-  
**Installed as new construction or replacement-**  
 Shatter-resistant tempered safety glass provides added protection- **Adjustable ball bearing tandem rollers enhance operation efficiency-** Custom doors with upgrades including frame and hardware color, argon gas, LOW-E glass, tinting, and grids available by special request- **Custom non-stock doors are special order with a 12 week lead time.**



Doors



◀ **84081**  
**Replacement Screen Door for Vinyl Framed Patio Doors- White Frame**  
 \*Measures 36 3/4" wide x 73 7/8" tall.



◀ **84073**  
**Keyless Handle for Aluminum Framed Patio Doors- Silver Frame with Wood Handle**



◀ **84073-V**  
**Keyed Handle for Vinyl Framed Patio Doors**

## COMMERCIAL BUILDING DOORS

**36" x 80" Heavy Duty Commercial Doors with 3 1/2" Wide Metal Jamb ▶**  
 \*Double-bored and prepped  
**Important note: These doors fit a rough opening of 37.25" x 81" (Inset of door frame is 37" x 80.75")**

- 84405-NW-LH-** Left Hinge Grey Pebbled Fiberglass over Hardboard- No Window
- 84405-NW-** Right Hinge Grey Pebbled Fiberglass over Hardboard- No Window
- 84404-** Left Hinge Smooth Steel Primed Skin w/ 10 x 10 Window
- 84405-** Right Hinge Smooth Steel Primed Skin w/ 10 x 10 Window



Shown here with right hinges, grey pebbled skin and 10 x 10 Window

**36" x 80" Heavy Duty Commercial Doors**

- 84401-** Right-Hinge- Grey Skin
- 84401-W-** Right-Hinge- White Skin
- 84401-LH- W-** Left-Hinge- White Skin



Shown here with right hinges, double-bored and prepped, grey pebbled skin and 10 x 10 Window

A closer view of the top corner of the inset for this door ▶



For concession truck doors and windows see page 19.



◀ **Fiberglass Outswing Doors**  
 \*Perfect for barns, sheds, and other utility building where you need room for big objects, or big people. White outside on white inside fiberglass skin, mill aluminum frame. Turn it upside down and it opens the other way! Lockset sold separately.  
**84324-LH- 48" x 80"**

For installation items see page 10.





**Doors**

# "CORDELL" EXTERIOR OUT-SWING 6-PANEL DOORS

An quality alternative for manufactured, modular or residential construction. This door sports a white heavy duty vinyl frame and a durable 6-panel core skin for enhanced safety and home security. These doors are double drilled to accommodate lockset and deadbolt. They are AAMA approved. They are pre-hung and ready to install.

\*Six Panel Design- 1 3/8" door thickness- Several Window Options available (See photos shown below)- Effective Polystyrene foam core insulation.

*Hardware, sealant tape and screws are sold separately.*



▲ Texas Star Window- Left Hinge



▲ 20 x 36 Integral Blinds- Left Hinge



▲ 20 x 36 Slider Window- Left Hinge



▲ 9-Lite Window- Right Hinge



▲ 15-Lite Window- Right Hinge



▲ Sunburst Window- Left Hinge



▲ No Window- Right Hinge



▲ 6-Lite Window- Left Hinge

***How to Identify Left or Right Hinge:***  
Look at the door from the *outside* of your home. The side with the hinges determines left or right hinge.

***See the chart on the next page for part numbers and availability!***

"Call size" refers to the stud-to-stud rough opening in the wall, not the door itself! To determine call size, see page 3.

For locksets, see page 13.  
For Installation Items see Page 10.





## **"CORDELL" EXTERIOR OUT-SWING 6-PANEL DOOR PART NUMBER CHART**

**Doors**

**Note: Part numbers are in red. Shaded part numbers represent doors we try to keep in stock- All non-stock doors have a 5-6 week lead time. The actual buck inset of these doors is 5/8" less than the call width and 3/8" less than the call height (For example: 34 x 76 call size has an exact inset of 33 3/8" x 75 5/8". "Call size" refers to the stud-to-stud rough opening in the wall, not the door itself! To determine your call size, see page 3. For Cordell combination exterior doors (residential-type front doors) see page 11. For locksets and hardware see page 13. For Installation Items see Page 10.**

Call Size and Hinge Side ▼	No Window	Sunburst Window	20 x 36 9-Lite Window	20 x 36 Slider Window	20 x 64 15-Lite Window	20 x 36 Integral Blinds Window	20 x 36 Texas Star Window	6-Lite Window
32 x 72 Left	881010	881011	881012	881014	881013	881015	88101TX	N/A
32 x 72 Right	881020	881021	881022	881024	881023	881025	88102TX	N/A
32 x 74 Left	881A10	881A11	881A12	881A14	N/A	N/A	881A1TX	N/A
32 x 74 Right	881A20	881A21	881A22	881A24	N/A	N/A	881A2TX	N/A
32 x 76 Left	881110	881111	881112	881114	881113	881115	88111TX	881116
32 x 76 Right	881120	881121	881122	881124	881123	881125	88112TX	881126
32 x 78 Left	881210	881211	881212	881214	881213	881215	88121TX	N/A
32 x 78 Right	881220	881221	881222	881224	881223	881225	88122TX	N/A
32 x 80 Left	881B10	881B11	881B12	881B14	881B13	881B15	881B1TX	N/A
32 x 80 Right	881B20	881B21	881B22	881B24	881B23	881B25	881B2TX	N/A
34 x 76 Left	881310	881311	881312	881314	881313	881315	88131TX	881316
34 x 76 Right	881320	881321	881322	881324	881323	881325	88132TX	881326
34 x 78 Left	881410	881411	881412	N/A	881413	881415	88141TX	N/A
34 x 78 Right	881420	881421	881422	N/A	881423	881425	88142TX	N/A
34 x 80 Left	881510	881511	881512	881514	881513	881515	88151TX	N/A
34 x 80 Right	881520	881521	881522	881524	881523	881525	88152TX	N/A
36 x 76 Left	881610	881611	881612	881614	881613	881615	88161TX	N/A
36 x 76 Right	881620	881621	881622	881624	881623	881625	88162TX	N/A
36 x 80 Left	881710	881711	881712	881714	881713	881715	88171TX	N/A
36 x 80 Right	881720	881721	881722	881724	881723	881725	88172TX	N/A
38 x 76 Left	881C10	881C11	881C12	881C14	881C13	881C15	881C1TX	N/A
38 x 76 Right	881C20	881C21	881C22	881C24	881C23	881C25	881C2TX	N/A





# EXTERIOR OUTSWING DOOR PARTS

Doors



▲ **Exterior Door Drip Caps- Mill Finish**  
84088-A-36M- 36" Length 84088-A- 39" Length  
84088-B-42M- 42" Length 84088-B- 43" Length



▲ **84065- Elixir Door Hinge**  
- Mill Finish- 3.5" Tall  
*\*Only works with Elixir brand doors!*



▲ **84086-POCA**  
Striker Plate for  
"Pocahontas" Doors  
Only



▲ **84089** Door Spring and Chain

Door Thresholds Mill Finish- Aluminum ▶

84191- 32" Length  
84192- 36" Length



## WINDOWS FOR EXTERIOR FIBERGLASS OUTSWING DOORS ONLY



▲ **84097- Sliding Window** for  
Exterior Door  
(14" x 27")



**84095- Stationary Slot Window** for  
Exterior Door (4" X 24") ▲

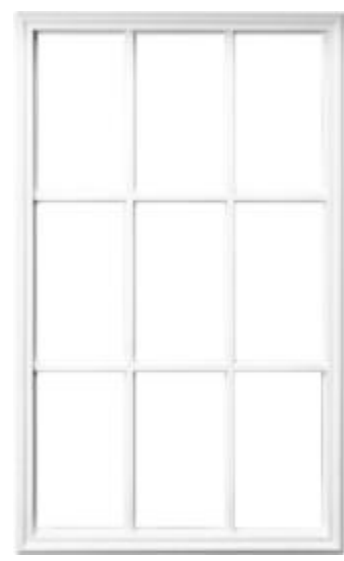

▲ **84098 - 9-Lite Window**  
for Exterior Door  
(20" x 36")



**Stationary Square Window** for  
Exterior Door (10" X 10")  
- White Frame,  
Clear Glass

**84095-10-** For 1 3/8"  
Thick Doors  
**84095-175-** For 1 3/4"  
Thick Doors

For locksets,  
see page 13.  
For sealants, screws  
and fasteners,  
see page 77.





## RV DOOR REPLACEMENT PARTS

Doors



▲ **Plastic Slider Bubble**  
**82246-B- Black**  
**82246-W- White**



◀ **Flush-Mount Non-Safety Lock**  
**82210-B- Black**  
**82210-C- Chrome**  
**82210-W- White**

*Special Order!*



◀ **Plastic Screen Door Handle**  
**82247-B- Black**  
**82247-S- Smoke**  
**82247-W- White**



◀ **12 x 21 Radial Corner Window with Obscure Glass**  
**82730-B- Black Frame**  
**82730-W- White Frame**

*Special Order!*

## STORM DOOR HARDWARE

**84090-W- Complete Storm Door Hardware Kit -White Only**  
\*Includes Door Handle, Closer and Spring/Chain



▲ **84085- Storm Door Closer/ Cylinder Only-Black**



▲ **84089 Storm Door Spring/ Chain Only**

For Storm Door Window Components see page 18.

For locksets, see page 13.  
For sealants, screws and fasteners, see page 77.





## "CORDELL" 6-PANEL COMBINATION DOORS

Doors



Shown here with 1/2 Integral Blinds Window and Left Hinges

A quality front door for manufactured, modular or residential construction. The Cordell 400 Series door sports a heavy duty frame and paneling for enhanced safety and home security. These doors are double drilled to accommodate lockset and deadbolt. They meet or exceed AAMA standards. They are pre-hung and ready to install.

**\*Standard Features- Six Panel Design- 1 3/4" Polyurethane Core- LVL Jamb for 4" Thick Wall- Heavy Duty 1 1/4" Self-Storing Storm Door- Mortise Door Core- Upgraded Weather Strip and Hinges- Vinyl Clad 24 Gauge Steel. Hardware, sealant tape and screws are sold separately.**

*See the chart on the next page for part numbers and availability!*

**Note: All non-stock doors have a 5-6 week lead time. Upgrades to 6" jamb, all-glass storm doors, and right hinge doors with left hinge storm doors, upgrades are available upon request.**

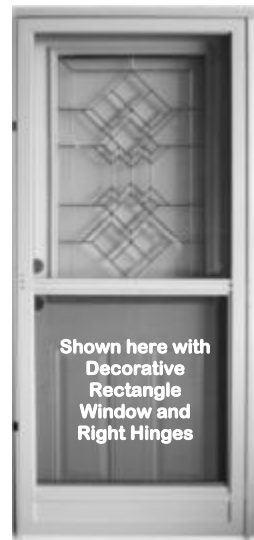

Shown here with Decorative Rectangle Window and Right Hinges

### ▼ Other Window Options ▼



Knocker/Viewer Only



Sunburst Window



Texas Star Window



9-Lite Window



15-Lite Window with All-Glass Storm



Slider Window



Decorative Oval Window with All-Glass Storm



Full Integral Blinds with All-Glass Storm



Decorative Sunburst Window

**How to Identify Left or Right Hinge:**  
Look at the door from the *outside* of the home. The side with the hinges determines left or right hinge.

**Shipping Note:** All the doors on this page must ship by freight unless located within local delivery route area, or if you are willing and able to pick them up at our location. Please contact us for an exact shipping and handling quote.

For Installation Items see Page 10.  
For Locksets, see page 13.





# "CORDELL" COMBINATION DOOR PART NUMBER CHART

Note: Part numbers are in red. Shaded part numbers represent doors we try to keep in stock- All non-stock doors have a 5-6 week lead time.

Call Size and Hinge Side ▼	Knocker / Viewer Only	Sunburst Window	22 x 36 9-Lite Window	15-Lite Window	Slider Window	1/2 Integral Blinds Window	Full Integral Blinds	Decorative Sunburst-Window	Decorative Rectangle Window	Decorative 3/4 Window	Texas Star
32 x 76 Left	882110	882111	882112	882113	882114	882115	882116	882117	882118	882119	88211TX
32 x 76 Right	882120	882121	882122	882123	882124	882125	882126	882127	882128	882129	88212TX
34 x 76 Left	882310	882311	882312	882313	882314	882315	882316	882317	882318	882319	88231TX
34 x 76 Right	882320	882321	882322	882323	882324	882325	882326	882327	882328	882329	88232TX
34 x 78 Left	882410	882411	882412	882413	882414	882415	882416	882417	882418	882419	88241TX
34 x 78 Right	882420	882421	882422	882423	882424	882425	882426	882427	882428	882429	88242TX
34 x 80 Left	882510	882511	882512	882513	882514	882515	882516	882517	882518	882519	88251TX
34 x 80 Right	882520	882521	882522	882523	882524	882525	882526	882527	882528	882529	88252TX
36 x 76 Left	882610	882611	882612	882613	882614	882615	882616	882617	882618	882619	88261TX
36 x 76 Right	882620	882621	882622	882623	882624	882625	882626	882627	882628	882629	88262TX
36 x 80 Left	882710	882711	882712	882713	882714	882715	882716	882717	882718	882719	88271TX
36 x 80 Right	882720	882721	882722	882723	882724	882725	882726	882727	882728	882729	88272TX
38 x 76 Left	882810	882811	882812	882813	882814	882815	882816	882817	882818	882819	88281TX
38 x 76 Right	882820	882821	882822	882823	882824	882825	882826	882827	882828	882829	88282TX
38 x 80 Left	882910	882911	882912	882913	882914	882915	882916	882917	882918	882919	88291TX
38 x 80 Right	882920	882921	882922	882923	882924	882925	882926	882927	882928	882929	88292TX
38 x 82 Left	8829C10	8829C11	8829C12	8829C13	8829C14	8829C15	8829C16	8829C17	8829C18	8829C19	8829C1TX
38 x 82 Right	8829C20	8829C21	8829C22	8829C23	8829C24	8829C25	8829C26	8829C27	8829C28	8829C29	8829C2TX

Doors

## "CORDELL" JAMB-MOUNT STORM DOORS



The storm doors on this page are made to mount on the extruded jamb of Cordell brand house-type doors (featured on previous page). Extruded jambs come out 1/2" from the wall.

Note: "Call size" refers to the stud-to-stud rough opening in the wall, not the door itself! For help on determining call size, see page 3.

### How to Identify Left or Right Hinge:

Look at the door from the outside of the home. The side with the hinges determines left or right hinge.

◀ This is a left hinged door

Shipping Note: All the doors on this page must ship by freight unless located within local delivery route area. Please contact us for an exact shipping and handling quote.

Call Size and Hinge Side ▼	Part Number	Call Size and Hinge Side ▼	Part Number
32 x 76 Left	88311	32 x 76 Right	88312
34 x 76 Left	88331	34 x 76 Right	88332
34 x 78 Left	88341	34 x 78 Right	88342
34 x 80 Left	88351	34 x 80 Right	88352
36 x 76 Left	88361	36 x 76 Right	88362
36 x 80 Left	88371	36 x 80 Right	88372
38 x 76 Left	88381	38 x 76 Right	88382
38 x 80 Left	88391	38 x 80 Right	88392
38 x 82 Left	8839C1	38 x 82 Right	8839C2

## DOOR AND WINDOW INSTALLATION ITEMS



We sell a variety of items designed specifically for the installation of exterior doors and windows. Fresh sealant tape, a must for the mounting flanges, can be found on page 77. Old screws can be re-used, but we recommend using new, slightly longer screws, especially if going into older wood in the wall. Screws are on page 77. You may also use silicone as an extra measure of sealant. We feature silicone on page 77. Drip caps of different sizes are featured on page 7. Finally, we offer an all-purpose door/window molding, seen on page 62, for the possible finishing touches needed to fit door and window frames neatly with vinyl siding.





# "DEXTER" RV DOORS WITH ROUNDED CORNERS

Doors



Outside view of right-hinged door, pictured with optional window and black flush-mount non-safety lock.

**Shipping Note: RV Doors must ship by freight. Please contact us by phone or email for an exact shipping and handling quote. Allow 4-5 weeks for shipping.**

## Series 5050 RC Combination Door

\* For travel trailers, motor-homes, or mobile homes- **Damage resistant fiberglass interior and exterior**- Precision one-piece aluminum frame is pre-squared and ready for installation- **Extruded hinges with stainless steel bushings and full-length hinge pin provide sturdy core to frame connection**- Complies with DOT FMVSS 206 and CMVSS 206- **Extruded aluminum screen door frame is designed to withstand heavy use**- Large molded slide-bubble glides easily and gives ready access to lock area- **Patented "Bullet-Latch" secures the screen door to the primary door and frame**- Butyl tape and screws are not included.



Inside view, pictured with mill screen door, white slide bubble, optional chrome flush-mount non-safety lock and window.

### Call Sizes Available:

Width Options: 22", 24", 26", 28", 30", 32"  
Height Options: 70", 72", 74", 76", 78"

**Build your own custom door online!**

Order from our website at [www.randgsupply.com/products/dexter-rv-door-with-radial-corners](http://www.randgsupply.com/products/dexter-rv-door-with-radial-corners)

**Note: The "call size" is the measurement of the stud-to-stud rough opening in the wall, and not the exact measurement of the door itself! For more help on how to measure for this door, please see page 3.**

## ROUNDED CORNER RV DOOR OPTIONS



◀ Round Corner Fixed Window Installed- 12" x 21" Clear- Black or White Frame- Clear, Obscure or Dark Grey Tint Glass



◀ 14" x 27" Slider Window Installed- Clear or Obscure Glass



◀ 4" x 24" Slot Window Installed- White Frame- Clear Glass



◀ Bauer NE Keyless Entry System Installed



◀ Flush-Mount Non-Safety Lock with Integral Keyed Deadbolt Installed- 2 keys (White, Black or Chrome Finish)



◀ Keyed Chrome Deadbolt Lockset (for doors with no screen door only)



◀ Flush-Mount Safety Lock Installed (Black Only)



Pebbled Fiberglass Finish -Also available in smooth finish.



Black or White Molded Slide-Bubble on Inside Screen Door ▶



▲ Keyed Chrome Knob x Lever Lockset (for doors with no screen door only)

### Additional Options:

- \*Hinges on left or right (looking from outside) \*Smooth White Fiberglass Exterior or Interior Skin (White only)
- \*Mill or White Door Frame \*Smooth Aluminum Exterior Skin (Red, Black, or Silver) \*Flexible Screw Cover for Outside Frame (White or Black)
- \*Other Inside Door Colors- Off-White (pebbled finish only) or Smooth Aluminum (White, Red, Black, or Silver)
- \*Other Outside Door Colors- Off-White (pebbled finish only) \*Without Screen Door
- \*7" Kick-Panel on Inside Screen Door (Black Aluminum or White Fiberglass)
- \*Black or White Finish Screen Door
- \*Interior Metal Trim Ring- White or Black

For installation items see page 10. For RV door replacement parts, see page 8.





# "DEXTER" RV DOORS WITH SQUARED CORNERS



Outside view, right-hinged door pictured with 12 x 21 window, black flush-mount non-safety lock, and mill frame.

**Shipping Note:** \*RV Doors must ship by freight. Please contact us by phone or email for an exact shipping and handling quote. Allow 4-5 weeks for shipping.

## Series 5050SQ Combination Door

\* For travel trailers, motor-homes, or mobile homes- **Damage resistant fiberglass interior and exterior**- Precision one-piece aluminum frame is pre-squared and ready for installation- **Extruded hinges with stainless steel bushings and full-length hinge pin provide sturdy core to frame connection**- Complies with DOT FMVSS 206 and CMVSS 206- **Extruded aluminum screen door frame is designed to withstand heavy use**- Large molded slide-bubble glides easily and gives ready access to lock area- **Patented "Bullet-Latch" secures the screen door to the primary door and frame**- Butyl tape and screws are not included.



Inside view, pictured with 12 x 21 window, black slide-bubble, mill screen door, and off-white pebbled interior door skin.

### Call Sizes Available:

Width Options: 22", 24", 26", 28", 30", 32", 34", 36"  
Height Options: 68", 70", 72", 74", 76", 78", 80"

### Build your own custom door online!

Order from our website at [www.randgsupply.com/products/dexter-rv-door-with-square-corners](http://www.randgsupply.com/products/dexter-rv-door-with-square-corners)

**Note:** The "call size" is the measurement of the stud-to-stud rough opening in the wall, and not the exact measurement of the door itself! For more help on how to measure for this door, please see page 3.

## SQUARED CORNER RV DOOR OPTIONS



◀ Round Corner Fixed Window Installed- 12" x 21" Clear- Black or White Frame- Clear, Obscure or Dark Grey Tint Glass



◀ Bauer NE Keyless Entry System Installed



◀ 14" x 27" Slider Window Installed- Clear or Obscure Glass



◀ Flush-Mount Non-Safety Lock with Integral Keyed Deadbolt Installed- 2 keys (White, black or chrome)

4" x 24" Picture Window- Clear Tempered Glass ▶



◀ Flush-Mount Safety Lock Installed (Black Only)

Pebbled Fiberglass Finish- Also available in smooth finish.

Black or White Molded Slide-Bubble on Inside Screen Door ▶



▲ Keyed Chrome Deadbolt Lockset (for doors with no screen door only)



▲ Keyed Chrome Knob x Lever Lockset (for doors with no screen door only)

For installation items see page 10. For RV door replacement parts, see page 8.

### Additional Options:

- \*Hinges on left or right (looking from outside) \*Smooth White Fiberglass Exterior or Interior Skin (White only)
- \*Mill or White Door Frame
- \*Smooth Aluminum Exterior Skin (Red, Black, or Silver)
- \*Flexible Screw Cover for Outside Frame (White or Black)
- \*Other Inside Door Colors- Off-White (pebbled finish only) or Smooth Aluminum (White, Red, Black, or Silver)
- \*Other Outside Door Colors- Off-White, (pebbled finish only)
- \*Without Screen Door \*7" Kick-Panel on Inside Screen Door (Black Aluminum or White Fiberglass)
- \*Mill or White Finish Screen Door





Doors

# EXTERIOR DOOR LOCKSETS

## Combination Exterior Lockset/ Deadbolt (Keyed-Alike)

\*Adjustable 2 3/8"- 2 3/4" plunger with both locksets. Same key operates both locksets. Key by latch deadbolt.



▲ **83010**- Double Combo- Chrome



▲ **83000**- Chrome Finish

## Exterior Locksets Complete- Uniquely Keyed \*Adjustable 2 3/8"- 2 3/4" plunger



▲ **84091**- Chrome Finish



▲ **84093**- Deadbolt Locksets (Key x Thumb Latch)  
\*Random-keyed. Chrome Finish



▲ **84100**- Drive-In Plunger for Exterior Lockset - 2 3/8"- 2 3/4" Backset



▲ **84100-DB**- Adjustable Drive-In Plunger for Deadbolt Lockset - 2 3/8"- 2 3/4" Backset





# INTERIOR DOORS AND PARTS

## Doors



### White Interior Door Slab

- 84397-W- 24" x 78"**
- 84197-W- 24" x 80"**
- 84398-W- 28" x 78"**
- 84198-W- 28" x 80"**
- 84399-W- 30" x 78"**

Our Interior Doors slabs are not pre-hung. Jambs, stiles, hinges and hardware sold separately. Interior door sizes match up with measurement of the slab door itself, width by height.



All door slabs are 1 3/8" thick.

### White 6-Panel Interior Door Slab

- 84390-78- 24" x 78"**
- 84390- 24" x 80"**
- 84391-78- 28" x 78"**
- 84391- 28" x 80"**



▲ **84200-SN- Non-Mortised Door Hinge**  
Satin Nickel



### Passage Knob/Knob Lockset

- 84195-B- Brass**
- 84195-SN- Satin Nickel ▲**
- 84195-ORB- Oil Rubbed Bronze**



### Privacy Knob/Knob Lockset

- 84194-B- Brass**
- 84194-SN- Satin Nickel**
- 84194-ORB- Oil Rubbed Bronze ▲**



### Privacy Lever/ Lever Lockset

- 84194-LC- Chrome ▲**

\*Fits 1 1/8" to 1 1/2" thick doors. Drive-in plunger fits 7/8" diameter hole.

### Metal Screw for Hinges



- ◀ **84201- 1" Long-Brass**
- 84201-SN- 1" Long- Satin Nickel**
- 84202- 2" Long-Brass**
- 84202-SN- 1 1/2" Long- Satin Nickel**



▲ **84196-C- Chrome Striker Plate**

### 84251- MDF Jamb Piece ▶

White- 3 1/2" Wide  
1/2" Thick, 96" Length



**84084-HP ▶ Door Knob Wall Guard-White Hard Plastic**  
\*Flexible construction. Adhesive backing. Use as knob bumper or wall repair.



◀ **84084 Door Knob Wall Guard-White Rubber**  
\*Flexible construction. Adhesive backing. Use as knob bumper or wall repair.

For door casing and wall trim, see page 23.





# "CROFT" VINYL-FRAMED EXTERIOR WINDOWS

All Croft windows on this page include: nail fin, .625" insulated LOW-E glass, half screen, limited warranties.

Windows



## "Savannah"

Our top line, 3.125" thick, 5/8" J-Channel for vinyl siding, 1 7/16" from nail fin to outside face.

We stock the most common sizes with a white frame, but almond and clay frame are available upon special request.



▲ Lap Flange designed for vinyl siding available in Savannah style only.

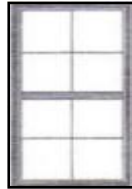

◀ Options available: Prairie or Colonial (Pictured) Grids



### ▼ Standard Call Size Chart ▼

The call size is the measurement (width by height) of the rough opening in the wall where your window will actually fit. Any size not shown in this chart can be custom made. Please contact us for more information.

▼ Also available upon special request ▼

## "Charleston"



High Grade, 3.25" thick, Beveled Frame, 1 1/2" from nail fin to outside face. No lap flange.

Available colors: White or Almond.



Obscure glass in other sizes available by special request.

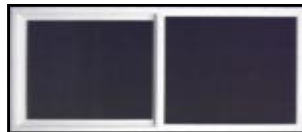

▲ Horizontal Sliding Windows available by special request.

Windows can be shipped by parcel or freight, depending on size and quantity, and it isn't cheap to ship them, just saying up front.

Call Size	White Frame - Clear Glass	White Frame- Obscure Glass
14" x 27"	93301	93301-OBS
14" x 40"	93302	93302-OBS
14" x 53"	93329	Special order
24" x 53"	93303	Special order
30" x 27"	93304	Special order
30" x 30"	93305	Special order
30" x 36"	93316	Special order
30" x 40"	93306	Special order
30" x 53"	93307	Special order
30" x 54"	93307-54	Special order
30" x 60"	93328	Special order
30" x 68"	93308	Special order
36" x 53"	93310	Special order
36" x 54"	93310-54	Special order
40" x 53"	93312	Special order
46" x 27"	93311	Special order
46" x 40"	93314	Special order
46" x 53"	93315	Special order
46" x 54"	93315-54	Special order

For sealants and screws see page 77. For window installation items, see page 10.

Contact us for more information about vinyl windows or visit our website at [www.randgsupply.com](http://www.randgsupply.com)





# "POCAHONTAS" EXTERIOR ALUMINUM WINDOWS



**Vertical Sliding Window With Clear Glass**

Many manufactured homes use a dual window system, with this exterior window comprising the outer part of the system. Our exterior windows can have a vertical or horizontal sliding sash with a half-screen. This window has a mounting flange that mounts onto a flush surface. We offer several common sizes of this window, but we can definitely make a special size not listed- Manufactured by Pocahontas, these windows are the industry standard and normally work in conjunction with an interior storm window (see page 18).

**Standard Features: Aluminum Frame (Mill or White Color)  
Inset depth 1 7/16" - 1/2 Screen- 1" Wide Exterior Flange**

**Window Options Include:**

**\*Grid Patterns \*Additional Lap Flange \*Obscure Glass**  
(Window options not available for 14 x 20 sizes)

**\*The call size is the estimated rough opening in the wall where the window fits. Inset size is slightly smaller than call size. Sizes not listed here are special order items. Please call for availability and pricing, and allow 16-20 weeks. Windows can be shipped by parcel or freight, depending on size and quantity, and it isn't cheap to ship them, just saying up front. Windows can be shipped by parcel or freight, depending on size and quantity, and it isn't cheap to ship them, just saying up front.**

**Windows**



**Vertical Sliding Windows with Obscure Glass ▼**

*\*Normally used for bathrooms and other private places.*

Obscure Vertical Slider Call Size (Inset Size)	Mill Frame
14 x 21 (14 1/4 x 21)	91020
14 x 27 (14 1/4 x 27)	91021
14 x 40 (14 1/4 x 39 5/8)	91022

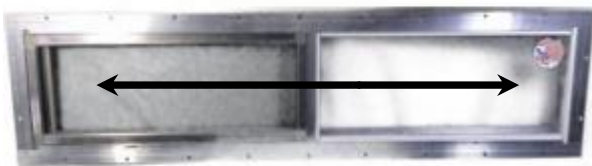

**▲ Horizontal Sliding Windows**  
(Opens from left to right from the outside)

Horizontal Slider Call Size (Inset Size)	Mill Frame
46 x 27 Clear (46 1/4 x 27)	91011-H
46 x 40 Clear (46 1/4 x 39 5/8)	91012-H
30 x 14 Clear (30 1/4 x 14)	91024
36 x 8 Obscure (36 1/4 x 8)	91023

Clear Vertical Slider Call Size (Inset Size)	Mill Frame	White Frame
14 x 20 (14 1/4 x 20)	N/A	91029-W
14 x 27 (14 1/4 x 27)	91001	N/A
14 x 40 (14 1/4 x 39 5/8)	91002	N/A
24 x 27 (24 1/4 x 27)	91003	91033-W
24 x 53 (24 1/4 x 53 1/4)	91017	N/A
30 x 21 (30 1/4 x 21 1/4)	91016	N/A
30 x 27 (30 1/4 x 27)	91004	91034-W
30 x 30 (30 1/4 x 30)	91005	91035-W
30 x 36 (30 1/4 x 35 5/8)	91027	N/A
30 x 40 (30 1/4 x 39 5/8)	N/A	91036-W
30 x 53 (30 1/4 x 53 1/4)	91007	91037-W
30 x 54 (30 1/4 x 54)	91007-54	91037-54
30 x 60 (30 1/4 x 60)	91028	N/A
30 x 68 (30 1/4 x 68)	91015	N/A
36 x 53 (36 1/4 x 53 1/4)	91014	91044-W
36 x 54 (36 1/4 x 54 1/4)	N/A	91044-W-54
40 x 53 (40 1/4 x 53 1/4)	91010	N/A
46 x 27 (46 1/4 x 27)	91011	N/A
46 x 40 (46 1/4 x 39 5/8)	91012	91042-W
46 x 53 (46 1/4 x 53 1/4)	91013	91043-W
46 x 54 (46 1/4 x 54)	91013-54	91043-W-54





## "POCAHONTAS" INTERIOR ALUMINUM STORM WINDOWS

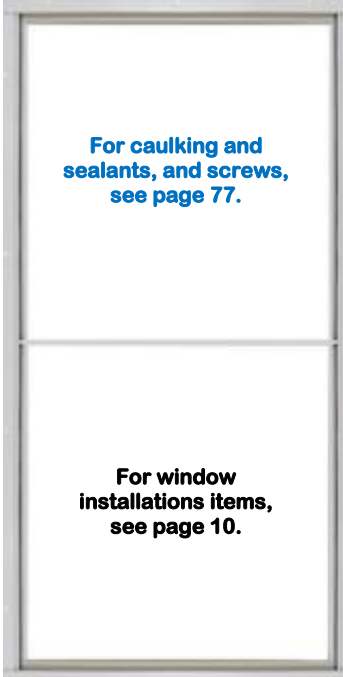

For caulking and sealants, and screws, see page 77.

For window installations items, see page 10.

Large flush mounting flange for easy installation- **Upper sash utilizes a dual durometer shape for superior weatherproofing. Removable upper and lower sash -Full interlock at meeting rail to provide window security and weatherproofing- Two spring loaded thumb latches for operation- Soft durable leaf vinyl provide additional weather seal- Latch strike allows varied opening heights for desired amount of ventilation.**

**Inset sizes must be measured carefully!**

**\*Available in white frame only! Options: Horizontal Sliding Window.**

**Call sizes not listed here are special order items (minimum order of 6 per size).**

**Please contact us for availability and pricing.**

**Smaller windows may ship by parcel. Larger windows and multiple window orders must ship by freight.**

▼ Call Size	Part Number	▼ Call Size	Part Number
14 x 40 <small>(Inset 14 1/4 x 39 3/4)</small>	<b>92002</b>	30 x 66 <small>(Inset 30 3/4 x 66)</small>	<b>92018</b>
30 x 27 <small>(Inset 30 1/4 x 27 3/4)</small>	<b>92004</b>	30 x 68 <small>(Inset 30 3/4 x 68)</small>	<b>92015</b>
30 x 30 <small>(Inset 30 1/4 x 29 3/4)</small>	<b>92005</b>	36 x 53 <small>(Inset 36 1/4 x 53)</small>	<b>92014</b>
30 x 40 <small>(Inset 30 1/4 x 39 3/4)</small>	<b>92006</b>	36 x 54 <small>(Inset 36 1/4 x 53)</small>	<b>92014-54</b>
30 x 53 <small>(Inset 30 1/4 x 53 1/4)</small>	<b>92007</b>	40 x 53 <small>(Inset 40 1/4 x 53)</small>	<b>92013</b>
30 x 54 <small>(Inset 30 1/4 x 54)</small>	<b>92007-54</b>	46 x 53 <small>(Inset 46 1/4 x 53)</small>	<b>92012</b>
30 x 60 <small>(Inset 30 1/4 x 60)</small>	<b>92019</b>	46 x 54 <small>(Inset 46 1/4 x 54)</small>	<b>92012-54</b>

Windows

The call size is the measurement (width by height) of the opening in the wall where your window will fit. Call sizes not listed here are special order items. Please contact us for availability and pricing.

## WINDOW REPLACEMENT PARTS

### ▼ Exterior Vertical Sliding Window Parts ▼

#### Steel Window Latches- Mill Finish

\*For Pocahontas Windows only



▲ **85900-LHP**- Left-Hand **85900-RHP**- Right-Hand ▲

\*For Phillips/ Kinro Windows only



▲ **85900-LHK**- Left-Hand **85900-RHK**- Right-Hand ▲

#### Latches for Storm Windows



▲ **85910-LH**- Left-Hand **85910-RH**- Right-Hand ▲

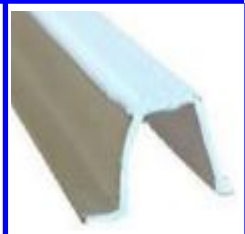

▲ **85920**- White Plastic Glazing- 6' Length

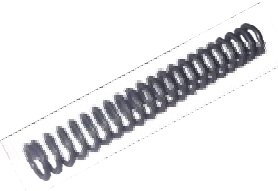

▲ **85901**- Spring for Storm Window Latch

\*Works with **85911** Storm Window Guides and **85900** Vertical Sliding Window Latches



**85911** Universal Corner Track Guides for Storm Windows



For caulking and screws see page 77.





# VINYL CORDLESS MINI-BLINDS

## Made by Designer's Touch

Add a natural look to any room with wood-like textured slats- provides security, privacy, and safety with no exposed cords- Wood-like texture and appearance- Mounts inside or outside window frames - Easy to operate with zero slipping when pushing the blind up and no rebounding when blind is fully extended- Slat rotation controlled by wand is precise- Lead-free, certified safe for kids and pets- Easy to operate- Durable and moisture resistant, these blinds are washable- Blind is 0.5 in. (1.27 cm) narrower than the order size- With upgraded 3 1/3" contemporary valance- Mounting hardware included- We recommend one mini-blind for every window in your home.

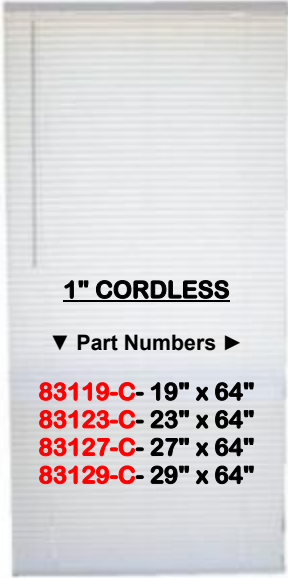

### 1" CORDLESS

▼ Part Numbers ►

- 83119-C- 19" x 64"
- 83123-C- 23" x 64"
- 83127-C- 27" x 64"
- 83129-C- 29" x 64"

- 83046-C- 30" x 36"
- 83130-C- 30" x 64"
- 83132-C- 32" x 64"
- 83272-C- 32" x 72"
- 83234-C- 34" x 72"
- 83035-C- 35" x 48"
- 83135-C- 35" x 64"
- 83136-C- 36" x 64"
- 83139-C- 39" x 64"
- 83146-C- 46" x 64"
- 83047-C- 47" x 36"
- 83048-C- 47" x 48"
- 83148-C- 48" x 64"

### 2" CORDLESS ►

▼ Part Numbers

- 83329-C- 29" x 60"
- 83330-C- 30" x 60"
- 83332-C- 32" x 60"
- 83336-C- 36" x 60"
- 83343-C- 43" x 60"
- 83347-C- 47" x 60"



Interior Refurb

# "POCAHONTAS" CONCESSION DOORS AND WINDOWS



Concession Doors  
(also called Awnings)

- 86400- 53" x 33"
- 86440- 64" x 40"
- 87440- 74" x 40"

Door core 2 x 4 wood construction designed to support gas shock installation- Back side view tempered glass- Extra heavy duty 3 1/2" extruded aluminum frame which serves as an integral jamb- Pre-punched side mounting flanges for easy installation. Steel hinges are riveted to outer frame- Mitered corners.

Three sizes- 53" Wide x 33" High (Suggested Rough Opening- 53 3/4" x 33 5/8"), 64" Wide x 40" High (Suggested Rough Opening- 64" x 40 1/4") and 74" x 40" (Suggested Rough Opening 74" x 40 1/4")



Concession Windows  
(O-X-X-O Pictured)

- 86400-HW- 53" x 33"- O-X-X-O
- 86401-HW- 53" x 33"- X-O-X
- 86440-HW- 64" x 40"- O-X-X-O
- 86441-HW- 64" x 40"- X-O-X
- 87440-HW- 74" x 40"- O-X-X-O
- 87441-HW- 74" x 40"- X-O-X

OXXO (two middle panes slide from center out) or XOX (two outside panes slide in towards center)-

# FLOOR REPAIR ITEMS



▲ Carpet Seam Binder- Aluminum- Mill Finish  
Used to bridge seams in separate pieces of carpet. Used with 61085 nails.  
61080- 4" x 12"



▲ 61085- Spiral Nails for Carpet Seam Binder  
6 x 1/4"- Aluminum-Chrome Finish- Sold in Packages of 50



▲ 86470 Heavy Duty Bracket for Concession Door  
(4 required)

Optional integrated concession door with gas struts. Extra heavy duty 3 1/2" extruded aluminum frame which serves as an integral jamb- Tempered glass- Mill finish frame- Screens not available for this item.



▲ 86450- 80# Gas Prop for Concession Door (2 required)





# INTERIOR ELECTRICAL SUPPLIES

Interior Refurb



▲ **50059-W**- Self-Contained Rocker Switches without Plate  
\*White finish. All switches come with snap-on backs.  
**50059-P** plate sold separately.



▲ **50063-W**- Body Only for Self-Contained Single Switch- White  
\*Use with **50063-PW** Plate



▲ **50064-W**- Body Only for Self-Contained Receptacles- White  
\*Use with **50064-PW** Plate



▲ **50050**- Ground Fault Circuit Interrupter (GFCI) Receptacle- White



▲ **50059-SW**- Replacement Rocker Switch Only



◀ **50059-P** Snap-on Cover plate only for old **50059** Rocker Switch and **50064-W** receptacle- Back tabs on sides- White



◀ **50059-PW** Snap-on Cover plate only for Wesco Rocker Switch- Back tabs on top and bottom- White



◀ **50063-PW** Snap-On Plate Only for Self-Contained Single Switch- \*Snap tabs on back are on the sides.



▲ **50059-DBLW** Replacement Snap-on Double Cover Plate only for Rocker Switch- White



▲ **50062** "Dog-Ear" Pawl for Self-Contained Switch/ Receptacle

For rangehoods, see page 25.  
For exterior electric fixtures, see page 60.

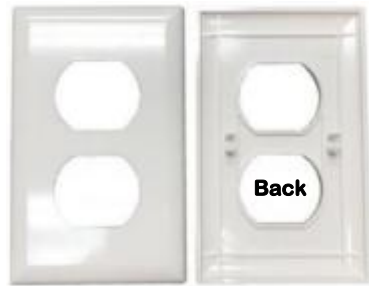

▲ **50064-PW**- Snap- On Plate Only for Self-Contained Receptacle- \*Snap tabs on back are on the sides.





# INTERIOR LIGHTING FIXTURES



◀ **50080**  
**Ceiling Dome Light Complete**  
**-Brushed Nickel Finish**  
 Insulated bulb plate-  
 Frosted glass dome-  
 Chrome finish dish  
 and finial nut- Bulb  
 not included.



◀ **50070-**  
**Fixture for 6" Round Light**  
**Globes- White Finish**  
 2" deep x 4 7/8" diameter. 1 socket.

Interior Refurb



▲ **50077- 13 1/2" Plastic "Dog Dish" Shade**  
 White- 13 1/2" diameter, 3 1/8" high. Use with #**50086** fixture and #**50083** nut.



◀ **50078- 12" Square Glass Shade- White**  
 \*Use with #**50086** fixture and #**50083** nut.



◀ **50086**  
**Insulated Metal Base for 50077, 50078 and 50079 shades**  
 \*White finish. 6" projection. 2 sockets.



▲ **50068- 6" Globe/ Clear Crystal Glass**  
 \*6" deep, 6" high, 3 1/4" neck. Use with # **50070** fixture.



◀ **69555- Lighted Bathroom Ceiling Exhaust Fan- Vertical Exhaust**  
 10 3/4" rough opening.



▲ **50083 White Plastic Finial Nut**

\*For use with part #'s **50077, 50078** and **50079** shades.



◀ **69556**  
**Replacement Light Cover for 69555 fan**

For exterior light fixtures, see page 60.





# WALL PANELING



\*Vinyl-Covered- White, "rolled-on texture" style finish.

## ◀ "Ruff-Stuff" Wallboard

**99915-RS**- 4' x 8' Wood Panel-  
5/32" (3.6mm) Thick

**99920**- 4' x 8' Sheetrock- 3/8" Thick

**99922**- 4' x 9' Sheetrock- 3/8" Thick

**99909**- Unfinished Sheetrock- 4' x 9'

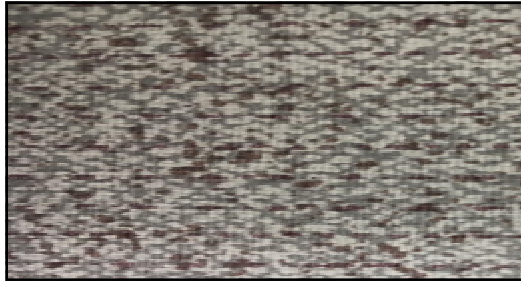

## ▲ **99915-HG**- 4' x 8' Lauan Wood Paneling- "Hampton Grey"- 5/32" (3.6mm) Thick

Specks of gray and brown against a white background, for an all-purpose color match.



## ◀ Wall Seam Tape-"Hampton Grey"

**99917-HG1**-  
1" x 150' Roll

**99917-HG2**- 2"  
x 150' Roll

**99917-HG3**-  
3" x 150' Roll

**99917-HG4**- 4"  
x 150' Roll

Interior Refurb

# CEILING ITEMS



## ◀ **99108**- C-Spray Gypsum Ceiling Panel 4' x 13' 9" x 5/16"

We do not ship ceiling or wall panels. You must come with your own vehicle to pick them up. No exceptions!



## ◀ **84255**- 3/8" MDF Ceiling Beam / Stile- White- 8" Wide x 97" Long



## ◀ **99106**- White Plastic Rosette- \*For use with **#99107**

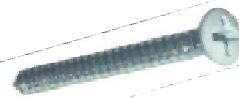

## ◀ **99107**- White Screw for **#99106** Rosette \*6 x 1 1/4" Phillips head.

*Wall Panels, Sheet Rock Panels and Ceiling Panels are Non-Returnable!*

For interior trim and molding, please see next page.





# Interior Molding Trim

## ▼ Flat Battens ▼

"Ruff-Stuff" Lauan Batten- White



- ◀ **95009-RS-** 1" x 8' Length
- 95020-RS-** 1 1/2" x 8' Length
- 95019-RS-** 2" x 8' Length

## ▼ Outside/Inside Corners ▼

"Tri-Mold" Lauan-Covered Corner Trim- 3" Wide- 8' Length

This trim can work as an outside \*or\* an inside corner- It can be bent either way!



Interior Refurb

Serenity Oak Batten



- ◀ **95020-** 1 1/2" x 8' Length

- ▲ **99924-RS-** "Ruff-Stuff" Finish- White (pictured above)
- 99924-HG-** "Hampton Grey"
- 99924-WH-** White **99924-MP-** Maple

Smooth Finish Batten



- ◀ **95009-W-** 1" x 8' Length - White
- 95020-W-** 1 1/2" x 8' Length - White

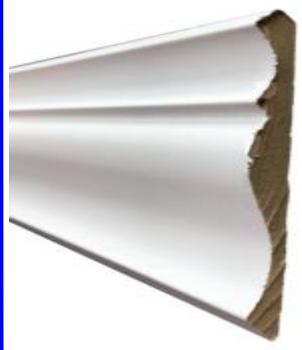

- ◀ **95035-** White Crown Molding - 1/2" Thick x 5 1/4" Tall x 10' Long

"Hampton Grey" Batten



- ◀ **95009-HG-** 1" x 8'
- 95020-HG-** 1 1/2" x 8'
- 95019-HG-** 2" x 8'



- ◀ **95012-W-** 7/16" x 8' Shoe/Quarter Round- White

- ◀ **95015-W-** Door Casing 2 1/8" x 8' Length Wood- White

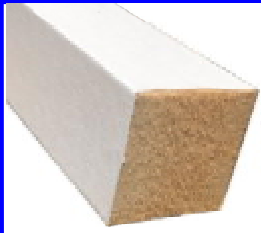

- Square Cleat/ Shoe \*5/8" x 5/8" x 8'
- ◀ **95025-W-** White





# INTERIOR VENTS AND GRILLS



◀ **Metal Floor Vents**

65170- 4" x 8" Brown  
 65170-W- 4" x 8" White  
 65171- 4" x 10" Brown  
 65171-W- 4" x 10" White  
 65175- 4" x 12" Brown  
 65175-W- 4" x 12" White  
 65174- 6" x 10" Brown  
 65174-W- 6" x 10" White

## Heavy-Duty Metal Floor Vents



65171-HD- 4" x 10" Brown  
 65171-WHD- 4" x 10" White



▲ 4" x 10" Steel Plated Oriental Grid Floor Vent  
 65171-GM- Gun Metal  
 65171-BLK- Black



## ◀ Floor Vent Collars

65180-6- 4" wide x 10" long x 6" deep  
 65180-4- 4" wide x 10" long x 8" deep  
 65180-10- 4" wide x 10" long x 10" deep



◀ 65171-BN- 4" x 10" Steel Plated Floor Vent- Brushed Nickel Finish



◀ **Floor Register Screws**  
 1 1/2" Length- Phillips Head  
 65176- Brown 65176-W- White



◀ 65171-AB 4" x 10" Antique Brass Fancy Metal Floor Vent



◀ 69554- Bathroom Ceiling Fan with Vertical Exhaust  
 69554-H- Bathroom Ceiling Fan with Horizontal Exhaust (not pictured)  
 \*7" wide- 115 volt- 50 CFM- White plastic grill cover- Non-lighted.



◀ 69555- Bathroom Ceiling Exhaust Fan- White plastic light cover- \*10 3/4" rough opening.



◀ 69554-CVR- Grill Cover Only for 69554 or 69554-H Bath Fan



◀ 69556- Lens Cover Only for 69555 Bathroom Ceiling Fan  
 \*Opaque- White Plastic- Snaps On- 8 1/4" Diameter

69552-BF ▶ Replacement Motor for all Bath Fans



◀ **Return Air Floor Grills- 12" x 20"**  
 53030- Brown 53030-W- White

Interior Refurb

For exterior vents, see page 60.





# RANGEHOODS AND ACCESSORIES



▲ Powered Range Hoods with Light and 5" Round Exhaust



▲ Powered Range Hoods with Light and Rectangular Exhaust

\*Note: Rectangular exhaust can be vertical or horizontal.

▼ Alcove Range Hood Part Number Chart ▼

Size and Color	Rectangular Exhaust with Light	Round Exhaust with Light
30" White	<b>69541-W</b>	<b>69543-W</b>
30" Black	<b>69541-B</b>	<b>69543-B</b>
30" Stainless Steel	<b>69541-SS</b>	<b>69543-SS</b>
42" White	<b>69542-W</b>	<b>69544-W</b>
42" Black	<b>69542-B</b>	<b>69544-B</b>
42" Stainless Steel	<b>69542-SS</b>	<b>69544-SS</b>



\*Rectangular exhaust can be vertical or horizontal- Single Speed Fan Powered by UL listed 115V Motor is standard- 2-Speed motor available upon request- Convenient Front Mounted Fan and Light Rocker Switches- Uses (1) 40 watt bulb (not included)- Available in White, Black, or Stainless Steel- **Leather-Grain Texture Surface is standard**- Includes dishwasher safe 8" x 8" Aluminum Grease Filter- 12" Cabinet depth- 18" Total capture area.



◀ **69549**  
Replacement Rocker Light Switch



◀ **69551-**  
Replacement Light/ Lens Cover for Range Hood- 3" x 9 1/2"



◀ **69553**  
Replacement Fan Blade for Range Hood-White Plastic (5 5/8" diameter)

## REPLACEMENT RANGE PARTS



◀ **Universal Reflector Pan for Removable Elements**  
**69742-** 6" Wide  
**69743-** 8" Wide



◀ **69550**  
Replacement Grease Filter for Range Hood- 8" x 8"



◀ **Universal 3-Turn Plug-In Range Elements**  
**69750-** 6" Wide- 1250 Watt  
**69751-** 8" Wide- 2100 Watt

## Replacement Range Hood Motors

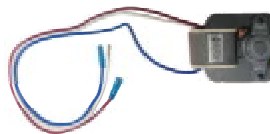

◀ **69552-3**  
115 Volt \*3 wire- for single speed or two-speed range hoods

Interior Refurb

For exterior vents, see page 56.





## HOME SAFETY



Home  
Safety

▲ **99101**- 9 Volt Battery Smoke Alarm Battery included

---



▲ **99102**- 120 AC Electric Smoke Alarm with Battery Back-Up





# STANDARD SIZED BATHTUBS



- \*Available in white or almond.
- \*Available in 27" x 54" and 30" x 60" Call Sizes.
- \*Composed of ABS Plastic with calves grain texture.
- \*Available in Standard Thickness (.225 mm), Heavy Gauge (.245 mm), or Permalux, with a smooth, high-gloss finish. (Permalux not available in almond)
- \*Drain on the left, right, or center.
- \*Drain hole measures 2" wide.
- \*Includes F-Strip for apron. Wall surrounds and tub trim sold separately.
- \*Our standard tubs measure 15 1/2" in height from floor to top of tub, not including the 1" mounting flange. The bowl itself is 11" deep. The tub sits on a solid 3.625" thick Styrofoam base.
- \*Fiberglass Tubs and Surrounds (27 x 54 Only) available upon special request .

For surrounds, see next page.  
 For trim kits, see page 34.  
 For drains and accessories, see page 36. For tub faucets see pages 37-39. For caulks and sealants see page 77. Use our chart below to determine the **part number** for the bathtub you need. ▼

Plumbing

Call Size/ Drain Position ▼	White Standard	White Heavy Gauge	White Permalux	Almond Standard	Almond Heavy Gauge
27" x 54" Left Hand Drain	38003-W	38003-WHG	38003-PX	38003	38003-HG
27" x 54" Right Hand Drain	38004-W	38004-WHG	38004-PX	38004	38004-HG
27" x 54" Center Drain	38025-W	38025-WHG	38025-PX	38025	38025-HG
30" x 60" Left Hand Drain	38026-WL	38026-WLHG	38026-LPX	38026-AL	38026-ALHG
30" x 60" Right Hand Drain	38026-WR	38026-WRHG	38026-RPX	38026-AR	38026-ARHG
30" x 60" Center Drain	38026-W	38026-WHG	38026-PX	NA	38026-HG





## STANDARD BATHTUB WALL SURROUNDS



**One-Piece Picture  
Frame Surround**  
\*57 <sup>3</sup>/<sub>8</sub> " height.



**5-Piece Tiled  
Caddy Surround**  
\*Designed to fit standard tub  
sizes, 27" x 54" & 30" x 60".  
Includes 3 wall pieces and  
2 corner caddies.  
\*57 <sup>3</sup>/<sub>8</sub> " height.



**One-Piece Tiled Surround**  
\* 57 <sup>3</sup>/<sub>8</sub> " height.



**3-Piece Tiled Surround**  
\* Also available in Permalux, with a  
smooth, glossier finish (White only)  
\* 57 <sup>13</sup>/<sub>16</sub> " height.

Plumbing

**About our Standard Tub Surrounds-** Composed of ABS Plastic with textured calves-grain finish. Available in white or almond. (24) **39013** or **39013-W** Rivets are strongly recommended for wall surround installation in conjunction with **38091** liquid adhesive. Use our handy chart below to determine the **part number** for the wall surround you need. ▼

Tub Size and Color ▶	27" x 54" White	27" x 54" Almond	30" x 60" White	30" x 60" Almond
5-Piece Tiled Caddy Surround	39000	39001	39018	39010
3-Piece Tiled Surround	39000-3	39001-3	39002-3	39003-3
3-Piece Tiled Surround- Permalux Finish	39000-PX	Not Available	39002-PX	Not Available
1-Piece Tiled Surround	39000-T	39001-T	Not Available	Not Available
1-Piece "Picture Frame" Surround	39000-PF	39001-PF	39002-PF	39003-PF

For rivets and adhesives, see page 34.





# GARDEN BATHTUBS



**Garden Tubs with Outside Step**

▲ \*Available in 40" x 54", 40" x 60", and 46" x 60" sizes. Available in heavy gauge (.265 mm) only. \*Available in Permalux, with a smooth, glossier finish (white only).

## About our Garden Tubs

- \*Support legs and installation instructions included.
- \*Drain hole measures 2" wide.
- \*Our garden tubs measure from 17" to 19 1/2" in height from floor to top of tub, not including the 1" mounting flange. The bowl itself is 13-15" deep. The tub sits on a sturdy 3.625" high slab of Styrofoam.
- \*All tubs available in white, some in almond.
- \*Drain in the center.
- \*Composed of ABS Plastic with textured calves grain.



**Garden Tubs Without Step-  
40" x 60"**

▲ Available in standard thickness (.242 mm) or heavy gauge thickness (.265 mm). 40" x 60" White Only.



**Garden Tubs Without Step- 40" x 54"**

▲ Available in white heavy gauge (.265 mm) only. \*Available in Permalux, with a smooth, glossier finish.



**Garden Tubs Without Step- 42" x 60"**

▲ Available in heavy gauge (.265 mm) only.

For trim kits and adhesive, see page 34. For tub faucets see pages 37-39. For drains and plumbing, see page 36. For caulks and sealants see page 77.

Call Size and Step ▼	Almond	Almond Heavy Gauge	White	White Heavy Gauge	White Permalux
40" x 54" Outside Step	38009	38009-HG	38009-W	38009-WHG	38009-PX
40" x 54" No Step	N/A	N/A	38011-W	38011-WHG	38011-PX
40" x 60" Outside Step	38017	38017-HG	38017-W	38017-WHG	38017-PX
40" x 60" No Step	38019	38019-HG	38019-W	38019-WHG	N/A
42" x 60" No Step	N/A	N/A	N/A	38020-W	N/A

Plumbing





# GARDEN BATHTUB WALL SURROUNDS



**One-Piece Picture  
Frame Surround**  
Fits 40" x 54", and 40" x 60"  
garden tub sizes.  
\*57 3/8" height .



**5-Piece Tiled Caddy  
Surround**  
\*Designed to fit all garden tub  
sizes. Includes 3 wall pieces and  
2 corner caddies.  
\*57 3/8" height.



**One-Piece Tiled Surround**  
Fits 40" x 54" and 40" x 60"  
garden tub sizes.  
\*57 3/8" height .



**3-Piece Tiled Surround**  
Fits 40" x 54" and 40" x 60" garden tub  
sizes. \*Also available in Permalux, with a  
smooth, glossier finish (white only)  
\*57 13/16" height.

Plumbing

About our Garden Tub Surrounds  
Composed of ABS Plastic with  
textured calves grain. Available in  
white or almond. (24) **39013** or  
**39013-W** rivets are strongly  
recommended for wall surround  
installation in conjunction with  
**38091** liquid adhesive.

Use our handy  
chart below to  
determine the  
**part number** for  
the wall surround  
you need. ▼

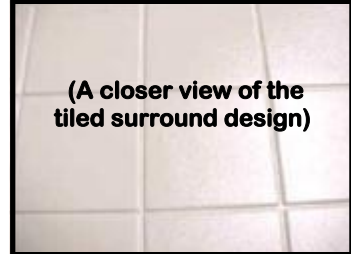

Tub Size & Color ▼	Tiled Caddy Surround	One-Piece Tiled Surround	One-Piece Picture Frame Surround	Three Piece Tiled Surround	Three Piece Tiled Surround- Permalux Finish
40" X 54" White	<b>39018</b>	<b>39018-T</b>	<b>39018-PF</b>	<b>39018-3</b>	<b>39018-PX</b>
40" X 54" Almond	<b>39010</b>	<b>39010-T</b>	<b>39010-PF</b>	<b>39010-3</b>	Not Available
40" X 60" White	<b>39018</b>	<b>39019</b>	<b>39019-PF</b>	<b>39019-3</b>	<b>39019-PX</b>
40" X 60" Almond	<b>39010</b>	<b>39019-A</b>	<b>39019-APF</b>	<b>39019-3A</b>	Not Available
42" X 60" White	<b>39018</b>	Not Available	Not Available	Not Available	Not Available
42" X 60" Almond	<b>39010</b>	Not Available	Not Available	Not Available	Not Available

For rivets and adhesives, see page 34.





## 54" CORNER BATHTUBS



\*Support legs and instructions for installation included. Available in white only. Also available in Permalux, with a smooth, glossier finish. Pictured with Corner Tub Trim installed- trim kit no longer available. Drain hole measures 2" wide.

◀ **38033**- 54" Corner Tub with Center Drain

**38033-PX**- 54" Corner Tub with Center Drain- Permalux Finish

**38034**- 54" Corner Tub with Right Hand Drain

**38034-PX**- 54" Corner Tub with Right Hand Drain- Permalux Finish

**38034-WP**- 54" Corner Tub with Right Hand Drain- Whirlpool  
(Designate right or left hand pump placement when ordering.)

**38034-WPX**- 54" Corner Tub with Right Hand Drain- Permalux Finish- with Whirlpool



▲ **38034-NA**- 54" Corner Tub with Right-Hand Drain- White- No Apron

\*Support legs and installation instructions included. \*Drain hole measures 2" wide. \*A deck must be built to support this tub.

**Shipping Note:** \*All tubs must ship by freight unless located within local delivery route area. Please see our price list for an estimated shipping and handling rate or email us for an exact quote.

## CORNER BATHTUB SURROUNDS



54" Corner Tub Wall Surrounds ▶

\*57 13/16" high.

**39025-2**- Two Piece Tiled Surround- White  
**39025-PX**- Two Piece Tiled Surround- White- Permalux Finish

\*(24) Rivets are strongly recommended for wall surround installation in conjunction with liquid or spray adhesive.

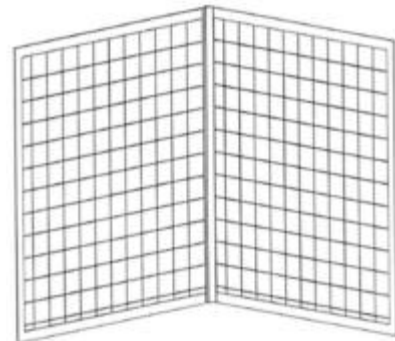

Trust us, it looks a whole lot better in person.

▲ **39025**- 54" Corner Tub Caddy Surround- White  
\*Includes 2 wall pieces and 1 corner caddy. \*Composed of ABS Plastic with calves grain texture. (24) Rivets are strongly recommended for wall surround installation in conjunction with liquid or spray adhesive. Corner Caddies require liquid adhesive.



◀ **38033-P**  
Replacement Access Panel for Corner Tub only  
(11 3/4" x 21")

For rivets and adhesives see page 34.  
For drains and plumbing, see page 36.  
For tub faucets see pages 37-39.  
For caulks and sealants see page 77.





## ISLAND (DROP-IN) BATHTUBS



42" x 60" Oval

Our island tubs are designed to fit inside (drop into) an island platform or pedestal. We are sorry but we do not sell the island platforms, only the tubs and accessories.

\*Island/ Drop-In Tubs available in white only. \*Composed of ABS Plastic with calves grain texture. \*Drain hole measures 2" wide and located in center.

◀ **38040-PX**- 42" X 60" Oval Tub with Permalux Finish

Shipping Note: All drop-in tubs must ship by freight unless located within local delivery route area. Please see our website for an estimated shipping and handling rate or contact us for an exact quote.

## TUB AND SHOWER DOORS

Plumbing



### ◀ Sliding Bypass Shower Doors

**38027**- For 28" x 54" Shower Pans

**38030**- For 35" x 48" Shower Pans

**38027-60**- For 35" x 60" Shower Pans

\*Doors are 66" high- Chrome Finish- Towel Bar Bracket/ Pull Handle- Standard Open Sill- Some assembly required- Includes installation instructions.

\*All tub and shower doors have obscure/ clouded glass and satin trim molding ▶



### ▲ Sliding Bypass Bathtub Doors

**38029**- For 54" Wide Bathtubs (27" x 54" Standard Tub and 40" x 54" Garden Tubs)

\*Doors are 58" high- Chrome Finish- Towel Bar Bracket/ Pull Handle- Standard Open Sill- Some assembly required- Includes installation instructions.



### ◀ Hinged Shower Doors for 32" and 36" Square Shower Pans

**38028**- 28" Wide

(Fits 26 5/8" x 28 5/8" opening)

**38032**- 32" Wide

(Fits 30 5/8" x 32 5/8" opening)

**38031**- 36" Wide

(Fits 34 5/8" x 36 5/8" opening)

\*Doors are 66" high.

For drains and plumbing, see page 36.  
For tub faucets see pages 39.  
For caulks and sealants see page 77.



◀ **30074**- 18" Towel Bar  
\*5/8" thick- Chrome Finish





## **PERMALUX™ TUBS, SHOWER PANS AND SURROUNDS**



Plumbing

Permalux™ Polymer Alloy is a high gloss/ high impact acrylic finish, hard as a rock and stain resistant, no chipping, peeling or spider webs!

**Comes with a 5 Year Warranty!**

**\*All Permalux Tubs and Shower Pans are also heavy gauge in thickness!**

**(Permalux finish only available in white.)**

Any of our tubs on pages 27-32 or shower pans on page 35 with **part numbers** ending with the suffixes **"-PX"**, **"-LPX"**, **"-RPX"** or **"-WPX"** are designated as Permalux items.

For drains and plumbing, see page 36.  
For caulks and sealants see page 77.





# BATHTUB MOLDING/ TRIM KITS

## Plastic Tub Trim Kits



\*Includes Trim, 2 Corner Pieces, 2 End Pieces, and Screws. Available in white or almond for all sizes. Use the chart on the right to determine the correct **part number** for your trim kit.

## ▼ Bath Trim Kit Part Numbers ▼

Tub Size ▼	Almond Plastic	White Plastic
27" x 54"	<b>38065</b>	<b>38060-W</b>
30" x 60"	<b>38065</b>	<b>38065-W</b>
40" x 54"	<b>38065</b>	<b>38065-W</b>
40" x 60"	<b>38065</b>	<b>38065-W</b>
42" x 60"	<b>38065</b>	<b>38065-W</b>
46" x 60"	<b>38065</b>	<b>38065-W</b>

# TUB AND SHOWER SURROUND ADHESIVES



### ▲ **38091**- Heavy Duty Adhesive

\*10.0 oz. Cartridge- All-purpose general construction adhesive. Adheres to wood, masonry, concrete and plastic.

### ◀ **99006**- "FlexMend" Spray Adhesive

\*17 Oz.- Multi-purpose adhesive for belly paper, tub and shower enclosures, carpet, etc.



Plumbing



◀ **39012**- Metal Flange Lock for Tubs and Shower Pans

### Replacement Caddies for Caddy Surround ▶

**39004**-Almond **39005**-White  
\*Sold by the pair. 58" Tall

## Plastic Rivets for Wall Surround ▼

Rivets are used to hold wall surrounds securely to drywall backing. We have learned through experience and customer feedback that 24 rivets are sufficient to install one surround. In the diagram on the right, we show a suggested pattern for where to evenly place the rivets around the wall surround. **This is not the only way to do it!** You may use as many rivets as you want, and place them wherever you wish. **Just remember that the rivets will be visible, so you want to space them out evenly, and of course use the same color of rivet as the wall surround!**



**39013**- Almond **39013-W**- White

\*Pictured in pairs, but sold individually.

A suggested pattern showing evenly placed rivets on a wall surround ▶

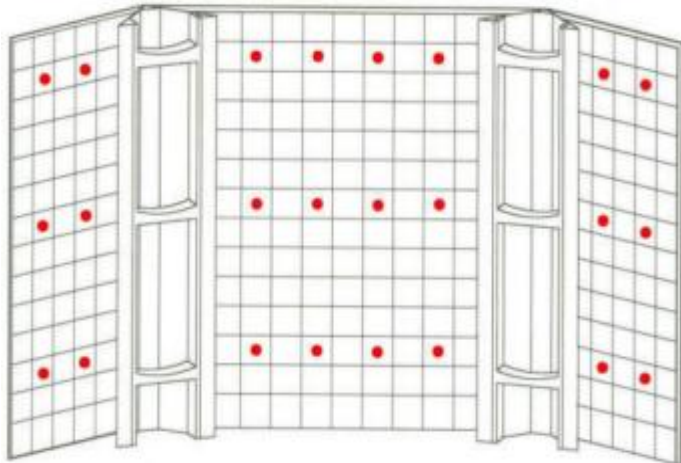



# SHOWER PANS AND WALL SURROUNDS



▲ \*28" x 54" Pan available in white or almond, heavy-gauge thickness (.245 mm) only- Also available in Permalux, with a smooth, glossier finish (white only)- Installation instructions included.



▲ \*35" x 48" and 35" x 60" available in heavy-gauge (.245 mm) only- Only 32" x 32" available in almond- Center drain only- Drain hole measures 3 1/4" wide- Installation instructions included.

▼ Pan Size and Drain	Almond	White	Almond Heavy Gauge	White Heavy Gauge	White Permalux
32" x 32" Center Drain	36096	36096-W	36096-HG	36096-WHG	Not Available
36" x 36" Center Drain	Not Available	36097-W	Not Available	36097-WHG	Not Available
28" x 54" Left Drain	Not Available	Not Available	38035-LH	38035-LW	38035-LPX
28" x 54" Right Drain	Not Available	Not Available	38035-RH	38035-RW	38035-RPX
28" x 54" Center Drain	Not Available	Not Available	38035-C	38035-CW	38035-CPX
35" x 48" Center Drain	Not Available	Not Available	Not Available	36092	36092-PX
35" x 60" Center Drain	Not Available	Not Available	Not Available	36093	36093-PX



▲ 3-Piece Designer Rings Surround for 28" x 54", 35" x 48" and 35" x 60" Pans Only. Also available in Permalux finish, white only. \*68" tall.



▲ 3-Piece Tiled Surround for 32" x 32" Pans, white only. \*68" tall.



▲ One-Piece Picture Frame Surround for 36"x 36" and 35" x 48" pans. White only for 36" x 36" and 35" x 48" \*68" tall.



▲ One-Piece Tiled Wall Surround for 32" x 32" Pans, white or almond \*68" tall.

\*39013 or 39013-W rivets are strongly recommended for installation in conjunction with 38091 adhesive. See page 34.

Surround Size and Color ▼	Three Piece Surround	One-Piece Tiled Wall Surround	One-Piece Picture Frame	Three Piece Tiled Surround-Permalux Finish
32" x 32" White	39015-3 (tiled)	39015	Not Available	Not Available
32" x 32" Almond	39014-3 (tiled)	39014	Not Available	Not Available
36" x 36" White	Not Available	Not Available	39017-PF	Not Available
28" x 54" White	38036-W (rings)	Not Available	Not Available	38036-PX
28" x 54" Almond	38036 (rings)	Not Available	Not Available	Not Available
35" x 48" White	38037 (rings)	Not Available	38037-PF	38037-PX
35" x 60" White	38038 (rings)	Not Available	Not Available	38038-PX

For shower accessories see page 32.  
For drains and plumbing see page 36.  
For shower faucets see pages 37-38.





# BATHTUB AND SHOWER PLUMBING



◀ **38005-M**  
Metal Drain  
for all Tubs  
and 28" x 54"  
Shower Pans



◀ **38005-TT**  
Metal Toe Touch  
Drain for all tubs and  
28" x 54" Shower  
Pans  
\*Requires plumbers putty



◀ **36098-SMALL-MTL**- Drain for  
28" x 54" Shower  
Pans Only- Metal  
Chrome Finish



◀ **36098**- 3 1/2"  
Flat Shower Drain  
for all Shower  
Pans *except* 28"  
x 54" size. \*Chrome  
Finish

Plumbing

*We offer two P-Trap Assemblies for Bathtub and Shower Drains.*

This assembly allows for a longer drop between the Drain and your P-Trap ▼

**38006**- 8" Tailpiece for  
Bathtub Drain ▶  
\*1 1/2" ABS FPT swivel nut.  
Use with **36204** P-Trap to  
extend below floor joist.



This assembly allows for a shorter drop between the Drain and your P-Trap ▼

**38014**- 1 1/2" ABS Swivel  
Adapter- FPT x Spigot ▶  
\*Works with **36203** P-Trap Only.  
Use with **36207** Black Rubber  
washer.



◀ **36207**- 1 1/2" Flat Rubber  
Washer  
\*Use with **38014** Swivel Adapter.



◀ **36204**-1 1/2" x 1  
1/4" ABS P-Trap- \*1  
1/4" Slip inlet x 1 1/2"  
Hub outlet with  
union joint. Use with  
**38006** Tailpiece  
only.

**36203**- ABS P-Trap- 1  
1/2" Hub x 1 1/2" Hub with  
Union Joint ▶  
Use with **36206** or **38013**  
Trap Adapter, or **38014**  
Swivel Adapter.



**36206**- ABS Trap  
Adapter ▶  
\*1 1/4" Spigot x 1 1/2" Slip.  
Works as a bridge be-  
tween **38006** tailpiece  
and **36203** P-Trap Only.



◀ **36203-PVC**- ABS  
P-Trap- 1 1/2" Hub x 1 1/2"  
Hub with Union Joint

**38013**- 1 1/2" ABS Trap Adapter-  
FPT x Spigot. ▶ Works with  
**36203** P-Trap Only. Use with  
**36207** Black Rubber washer.



For pipe cements see page 77.





# SHOWER HEADS AND 4" FAUCETS



▲ **36100-RF** "Rainfall" Shower Head, Arm, and Flange- Chrome



▲ **36100-LRG** Shower Head, Arm, and Flange with Large Head- Chrome Finish

Plumbing

## Shower Head, Arm, and Flange- 2" Wide Head



▲ **36100** Chrome



▲ **36100-AFO** Shower Arm and Mounting Flange only - Chrome Finish



◀ **36099** Chrome Shower Head Only



▲ **36100-PB** Polished Brass



▲ **36134-T-** 2 Valve Shower Faucet- Chrome- Teacup Lever Handles



◀ **36152** Handheld Shower Head/ Hose/ Bracket  
\*Works with **36151** Tub/Shower (Page 38) or **36173** Lavatory Faucet (Page 39)



▲ **36134-** 2-Valve Shower Faucet- Plastic Waterways- Chrome Finish

**\*All items on this page have 1/2" MPT inlets.**

For 8" shower faucets, see next page.





# 8" SHOWER FAUCETS



▲ **36178 - 8" Concealed Shower Valve**  
\*Includes shower head, arm and flange.



◀ **36174-BR - 8" Shower Valve Only- Chrome with Brass Inlets**



◀ **36174- Shower Valve Only - Chrome with Plastic Inlets.**

# 4" TUB/ SHOWER DIVERTERS



◀ **36172 - Tub/Shower Diverter- Single Control Knob- Chrome Finish**

Plumbing

# 8" TUB/ SHOWER DIVERTERS



◀ Straight inlets means all inlets are lined up!



◀ Offset inlets means the middle inlet is lower!



◀ **36129-PXST** Straight Inlets-Chrome Finish-"Phoenix" Style-Plastic body  
\*Does not include shower head, arm and flange.



◀ **36128- Offset Inlets-Plastic Body- Chrome Finish**  
\*Does not include shower head, arm and flange. Diverter knob on top of faucet near wall.



▲ **36129-ORB- Straight Inlets- Oil Rubbed Bronze Finish- Plastic Body**  
\*Includes shower head, arm, flange.



◀ **36128-EMP- Offset Inlets- Plastic Body- Chrome Finish**  
\*Does not include shower head, arm and flange. Diverter knob at the front of spout.



▲ **36129-BR** Straight Inlets- Brass Waterways-Chrome Finish.  
\*Includes shower head, arm and flange. Diverter knob at the front of spout.



◀ **36175- Concealed 3-Valve Brass Tub/ Shower Diverter**  
\*Includes shower head, arm and flange.

For faucet handles and parts, see page 41.  
For faucet connections, see page 42.  
\*All items on this page have 1/2" MPT inlets.





# DECK MOUNT TUB FILLERS

\*All Deck Mount Tub Fillers have 8" - 14" Adjustable spread hoses.



◀ **36189**  
Chrome Finish-  
Brass  
Waterways



▲ **36189-HOSE-EMP**  
Replacement Hose for  
Empire Deck Faucets  
\*1/2 Female Pipe Thread x 3/8" Male Pipe Thread-  
13" length

Replacement Mixer Tees for Deck Mount Faucet



◀ **36189-TEE**  
For Phoenix



◀ **36189-SP**  
Replacement  
Spout For Deck  
Mount Tub Filler-  
Plastic

Plumbing

# LAVATORY FAUCETS



▲ **36177**- Dual Round Handles- Chrome  
Finish- Plastic Waterworks



▲ **36173**- Dual Round Handles- Chrome  
Finish with connection for shower hose



▲ **36177-BRSL**-Single Lever- Brushed  
Nickel Finish- Brass Waterworks



▲ **36177-BR**- Dual Round Handles- Chrome  
Finish- Brass Waterworks-  
\*Less Pop-up Assembly.

For faucet handles and parts, see page 41.  
For faucet connections, see page 42.

\*All faucets on this page have 1/2" MPT inlets.





# KITCHEN AND BAR FAUCETS



◀ **36181-HI-PDS-**  
With Pull-Down  
Spray Hose- High  
Rise Neck- Chrome  
Finish



▲ **36183-** Single Lever Kitchen Faucet-  
Chrome Finish, Brass Body with Spray  
Hose



◀ **36181-HI-BR-**  
Chrome Finish With  
Spray Hose -  
Brass Body



▲ **Less Spray Hose- Chrome Finish**  
- Dual Round Handles



◀ **36180-HI-T-BR-BN**  
No Spray Hose-  
Brushed Nickel  
Finish- Brass Body

**36180-** Plastic Body ▲  
**36180-BR-** Brass Body



◀ **36186**  
With Pull-Down Spray  
Hose- Single Handle-  
Brushed Nickel Finish-  
Brass Body



▲ **36160-** 4" Bar Faucet with Round  
Handles



◀ **36187-** With Pull-  
Down Bullet Spray  
Hose- Single Handle-  
Brushed Nickel Finish-  
Brass Body



◀ **36188**  
Pull-Down Coil Spray  
Hose- Brushed Nickel  
Finish- Brass Body



◀ **36160-LVR-BR**  
4" Bar Faucet with  
Lever Handles  
(ADA)

For faucet handles and parts, see page 41.  
For faucet connections, see page 42.

Plumbing





# REPLACEMENT FAUCET PARTS



▲ **36190**- 1 1/2" Wide Universal Handles. Sold per pair.



◀ **36145-PH**- Nylon Seat for Phoenix Sink-Mount Faucets & Exposed Tub/Shower Diverters



◀ **36145-PHB** Brass Seat for Phoenix Sink-Mount Faucets & Exposed Tub/Shower Diverters



◀ **36147-PH** Replacement Stem/Bonnet for Phoenix Sink-Mount Faucets & Exposed Tub/Shower Diverters  
\*Replaces Phoenix Stem/Bonnet 41 or 43-5. Use with **36145-PHB** Seat



◀ **36148-PH** Phoenix Replacement Stem/Bonnet for Deck-Mount Faucets & Tub/Shower Diverters  
Replaces Phoenix Stem/Bonnet 61-5. Use with **36146-PHB** Seat



◀ **36142** Replacement Stem/Bonnet for Empire Garden Tub Faucets Only

▲ **36146-PHB**- Phoenix Replacement Seat for Concealed Tub/Shower Diverters  
\*Sold singularly.



▲ **36144** - Replacement Seat for Empire Lavatory Faucets



◀ **36140** Replacement Stem/Bonnet for Empire Lavatory Faucets Only



◀ **36141** Replacement Stem/Bonnet for Empire Tub and Shower Faucets



◀ **36145**- Replacement Faucet Seat for Empire Tub and Shower Faucets

Plumbing





# FAUCET CONNECTIONS



▲ **1/2" FPT x 3/8" Compression  
Faucet Riser**

**24320-COMP**- 12" Length  
**24320A-COMP**- 16" Length  
**24321-COMP**- 20" Length

\*Use with **039148** Stop Valve (See page 51)  
or **24310-COMP** ▼



▲ **1/2" FPT x 1/2" FPT  
Faucet Riser**

**22320**- 12" Length  
**22321**- 20" Length

\*Use with **039148** Stop Valve (See page 51)  
or **02889** Flair-It Stop Valve



▲ **24310-COMP**  
**1/2" Pex/ Brass x 3/8"**  
**Compression- 1/4 Turn-**  
**Straight Stop Valve**



◀ **02889 1/2" x 1/2" MPT  
Flair-It Stop Valve**



◀ **24324- Brass/Pex  
Swivel Elbow- 1/2" Barb x  
1/2" FPT**



▲ **Flair-It Straight  
(In-Line) Stop Valve**  
**02880- 1/2" x 1/2"**



◀ **24310- 1/2" Brass/  
Pex- 1/4 Turn-Straight  
Stop Valve**



◀ **02435- 1/2"**  
**Saniprene**  
**Swivel Seal**  
**for**  
**Flair-It**  
**Fittings**



▲ **Flair-It Swivel  
Faucet Connection**  
**02873- 1/2" x 1/2" FPT**



▲ **24309- Faucet  
Connection Complete-**  
**1/2" Brass/Pex Barb x 1/2"**  
**Female Pipe Thread**

Plumbing





# KITCHEN SINKS AND PLUMBING



▲ **33" x 19" Double Bowl Stainless Steel Sink-**  
 \*Four holes in ledge, one plugged. Fits cutout hole of 32 1/2" x 18 1/2".  
**36199-7- 7" Deep Bowl 36199-8- 8" Deep Bowl**

Plumbing



▲ **38008-M- Chrome-**  
**Stainless Steel 3 1/2" Basket**  
**Strainer**



▲ **36160-SINK**  
**15" x 15" Single Bowl**  
**Stainless Steel Bar Sink**



◀ **Soap**  
**Dispensers**

**36185- Chrome Finish**  
**36185-ORB- Oil Rubbed**  
**Bronze Finish**



◀ **36160-DRAIN**  
**Stainless Steel**  
**Bar Sink Strainer-**  
**Fits 2 1/2" Hole**

For kitchen faucets see page 40.  
 For drains & plumbing see page 45.





## LAVATORY SINKS



▲ 17" x 20" Plastic Oval Sink  
\*No overflow. Includes clips and screws.  
**36200- White**  
**36201- Almond**



▲ 16" x 20" Plastic Rectangular Sink  
\*No overflow. Includes clips and screws.  
**36200-R- White**



▲ 17" x 20" Plastic Rectangular Sink  
\*No overflow. Includes clips and screws.  
**36200-R17- White**



▲ **36200-PO**  
17" x 20" Porcelain Lavatory Sink  
\*Includes overflow chamber- Fits cutout opening of 13 1/2" x 15 1/2"

For lavatory faucets see page 39. For drains & plumbing see next page.

Plumbing





# SINK DRAINS AND PLUMBING

**Continuous Waste Drain Assemblies for Kitchen Sinks**  
Telescoping- With 1 1/2" rubber gasket.



▲ **38007**  
Less Dishwasher Tailpiece

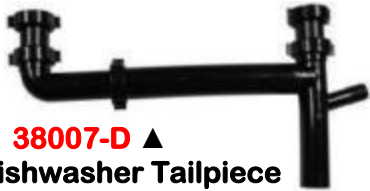

**38007-D** ▲  
With Dishwasher Tailpiece

**36203- ABS P-Trap-1 1/2" Hub x 1 1/2" Hub with Union Joint.** ▶  
Use with **38014** Swivel Adapter (Page 36) or **36206** P-Trap Adapter.



◀ **36204- 1 1/2" x 1 1/4" ABS P-Trap**  
\*1 1/4" Slip inlet x 1 1/2" Hub outlet with union joint.



◀ **36094- 1 1/2" ABS Pro Vent Check with adapter.**



◀ **36094-VCO**  
ABS Pro-Vent Check Adapter Head Only

**36206- ABS Trap Adapter** ▶  
\*1 1/4" Spigot x 1 1/2" Slip.  
Works as a bridge between CO Plug and **36203** P-Trap.



◀ **CO Plugs- Drains for Lavatory Sink with no Overflow- Removable Pop-stop.**  
**36202- Chrome**  
**36202-W- White**



◀ **36202-STP**  
Replacement Stopper Only for **36202** Chrome CO Plug



▲ **36202-NOFLW-BN-**  
Brushed Nickel



◀ **36207- 1 1/2" Flat Rubber Washer**



**CO Plugs- Drains for Lavatory Sink with Overflow-Removable Pop-stop.**  
▲ **36202-OFLW- Chrome**  
**36202-OFLW-ORB- Oil Rubbed Bronze**

**CO Plugs- Drains for Lavatory Sink with No Overflow-Removable Pop-stop.**



**36202-NOFLW-ORB-**  
Oil Rubbed Bronze ▶

For disposals and dishwasher related items see next page.



Plumbing



# PLUMBING ACCESS PANELS

\*Can be installed either surface mount or on rough framing. Made of white ABS plastic with UV stabilizer.



**38100**  
14" x 14"  
Access  
Panel

In most instances in mobile homes, rear access to the tub/shower faucet can only be made from the wall of an adjacent room. Covers that unsightly mess you made crumbling the sheetrock away with your hands. Will come in handy later!



**38099**  
6" x 9" Panel

# WASHING MACHINE RELATED ITEMS

Plumbing



**25321**- 1/2" MPT  
Metal Boiler Drain  
\* 3/4" GHT outlet.



**25336**- Universal Washer Box  
\*High-impact plastic construction. White.

# DISHWASHER RELATED ITEMS



**24350** - 1/2"  
MPT x 3/8" MPT  
Brass Elbow



**02880**-  
Plastic Straight  
Stop Valve 1/2" x  
1/2"



**02820**  
Plastic Tee-1/2"  
x 1/2" x 1/2"





# TOILET COMPONENTS



◀ **30066-W**  
White  
Plastic  
Toilet Seat

**30062-F** ▶  
Anti-Siphon  
Fill Valve



▲ **24313-COMP**- 12" Toilet  
Riser Connection-  
\*3/8" Compression x 7/8" Ball Cock-  
Stainless Steel- \*Use with **039149** Stop  
Valve (See Page 51)



◀ **039113**-  
Brass Push  
Fit 18" Toilet  
Riser w/  
Stop Valve



◀ **30075**- Toilet  
Tissue Holder  
(Exposed  
Screw)



▲ **22313**- 12" Toilet Riser Connection  
\*1/2" Female Pipe Thread x Ball Cock Thread.



◀ **30061-KR**-  
"Korky Red"  
Replacement  
Rubber Flush  
Valve Flapper



◀ **30071**-  
Plastic  
Float Ball



◀ **30060**-  
Closet Bolt for  
Floor Flange  
\*Sold by the pair (as  
pictured).



◀ **30064**-  
Wax Ring  
with Flange

For closet floor flanges, see page 52.

Plumbing





# FLAIR-IT PLUMBING FITTINGS

**Revolutionary! Simple! Reliable!**

State of the art plumbing system for manufactured housing, residential, recreational vehicles, or marine- May be used with polybutylene (gray or black) tubing or new PEX (red, blue or white) tubing-  $\frac{3}{4}$ " fittings require a special bushing when used with polybutylene- Flared-Cone and nut fittings- Designed for normal hot and cold potable water- Reusable fittings- no corrosion or scaling- Simple installation- No crimping tools, cements, solder or Teflon tape needed- Complies with ASTM D 3309 and NSF listed (standard 14) Sold individually or in bags of ten.

## How to use Flair-It Fittings



▲ Step 1- Slide nut over tubing.



▲ Step 2- Insert fitting into tubing until it rests against the fitting threads.



▲ Step 3- Slide nut on to the threads and tighten securely.

Plumbing

### ▼ Tee

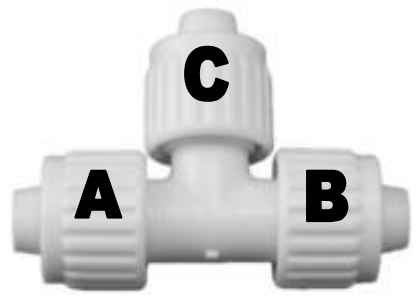

(Read **A x B x C** or **B x A x C** for sizes)

- 02820**-  $\frac{1}{2}$ " x  $\frac{1}{2}$ " x  $\frac{1}{2}$ "
- 02825**-  $\frac{3}{4}$ " x  $\frac{1}{2}$ " x  $\frac{3}{4}$ "
- 02826**-  $\frac{3}{4}$ " x  $\frac{3}{4}$ " x  $\frac{1}{2}$ "
- 02827**-  $\frac{3}{4}$ " x  $\frac{3}{4}$ " x  $\frac{3}{4}$ "
- 02830**-  $\frac{1}{2}$ " x  $\frac{1}{2}$ " x  $\frac{3}{8}$ "



▲ **Swivel Tee**  
(female swivel connection in the middle)  
**02821**-  $\frac{1}{2}$ " x  $\frac{1}{2}$ " x  $\frac{1}{2}$ "  
FPT



▲ **Male Tee**  
(with male connection in the middle)  
**02822**-  $\frac{1}{2}$ " x  $\frac{1}{2}$ " x  $\frac{1}{2}$ "  
MPT



◀ **02890**  
Universal  
Tubing Cutter  
for Poly, PEX,  
PVC or CPVC  
pipe.



◀ **02890-HD**  
Heavy Duty  
Tubing Cutter  
for plastic, vinyl  
and rubber  
tubing up to  
1 5/8" OD

For "Pex" Tubing see page 54.





# FLAIR-IT PLUMBING FITTINGS



▲ Elbow (Flair-It Connections on both ends)  
**02800**- 1/2" x 1/2"  
**02815**- 3/8" x 3/8"



◀ Male Elbow (with MPT Connection on one end)  
**02808**- 3/4" x 1/2" MPT  
**02809**- 3/4" x 3/4" MPT



▲ Female Street Elbow (with FPT connection on one end)  
**02813**- 3/4" x 3/4" FPT



▲ Swivel Elbow (Tub and Faucet Connection to Flair-It)  
**02816**- 1/2" x 1/2" FPT Swivel  
**02817**- 3/8" x 1/2" FPT Swivel



▲ Drop Ear Elbow (Shower and Tub connection to Flair-It)  
**02801**- 1/2" x 1/2"



◀ Female Adapter (with female connection on one end)  
**02841**- 1/2" x 1/2" FPT Adapter  
**02847**- 3/4" x 3/4" FPT Adapter



▲ Male Adapter (with male connection on one end)  
**02842**- 1/2" x 1/2" MPT  
**02850**- 3/8" x 3/8" MPT  
**02868**- 1/2" x 3/4" MPT  
**02848**- 3/4" x 3/4" MPT

## Garden Hose Adapters (Hose Connections)



▲ **02866**- 1/2" x 3/4" FPT Adapter



▲ **02867**- 1/2" x 3/4" MPT Adapter



▲ **02859**- 3/8" Threaded Cap  
 (used to cap off a plastic fitting)



Swivel Connections  
**02849**- 3/4" x 3/4" FPT Swivel  
**02856**- 1/2" x 3/4" FPT Swivel  
**02873**- 1/2" x 1/2" FPT Swivel (Faucet Connection)

Plumbing





# FLAIR-IT PLUMBING FITTINGS



▲ **Straight (In-Line) Stop Valve**  
**02880**- 1/2" x 1/2"



▲ **Coupling**  
**02840**- 1/2" x 1/2"  
**02846**- 3/4" x 3/4"



▲ **06792**  
**Polybutylene to Flair-It Adapter/Bushing**  
*\*Only needed when connecting any 3/4" Flair-It fitting to Polybutylene tubing.*

Plumbing



▲ **02862**- 3/8" **Plug**  
 (used to plug into ends of tubing)



▲ **02912**- **Three-Way Stop Valve**-  
 1/2" x 1/2" MPT x 1/2"



▲ **02869**- 3/8" x **Ball-cock Swivel Toilet Connections**



▲ **Saniprene Swivel Seal**  
**02435**- 1/2"



▲ **02889**- 1/2" x 1/2"  
**MPT Stop Valve**



▲ **02872**  
 3/4" MPT x **Water Heater Connection**





# BRASS PUSH-FIT FITTINGS

Do-It-Yourself pipe repair for PEX, CPVC and copper pipe only. Easily removable and re-usable with full, unrestricted flow. No need for tools, glue, or solder to install. 75 year warranty- the industry's best. Compare with popular name-brand alternatives at the big hardware stores. Save yourself time and money!



◀ Tees  
**039015**- 1/2" x 1/2" x 1/2"  
**039016**- 3/4" x 3/4" x 3/4"  
**039017**- 3/4" x 3/4" x 1/2"



◀ Couplings  
**039001**- 1/2" x 1/2"  
**039002**- 3/4" x 3/4"  
**039003**- 3/4" x 1/2"



◀ Elbows  
**039011**- 1/2" x 1/2"  
**039012**- 3/4" x 3/4"



◀ Male Adapters  
**039008**- 1/2" **039009**- 3/4"



▲ **039065**  
 1/2" Female Pipe  
 Thread x 1/2"  
 Female Elbow



▲ Female  
 Adapters  
**039005**- 1/2"  
 FPT x 1/2"  
**039006**- 3/4"  
 FPT x 3/4"



▲ **039148**- 1/2" x 1/2" Stop  
 Valve



▲ **039149**- 1/2" X 3/8" Compression Stop Valve- Works with Faucet  
 Connections **24320-COMP**, **24320A-COMP** and **24321-COMP**  
 (See Page 42)



◀ End Cap/  
 Stop  
**039020**- 1/2"  
**039021**- 3/4"



◀ Ball  
 Valves  
**039035**- 1/2"



▲ **039123**- 3/4" Check  
 Valve



◀ **039105**-  
 18" Faucet  
 Riser w/ Stop  
 Valve



◀ **039113**  
 12" Toilet Riser  
 w/ Stop Valve



▲ Disconnect Clip Tools  
**039031**- 1/2"  
**039032**- 3/4"  
 \*Tool for easy removal of Push-Fit  
 fittings from pipe. To remove a  
 fitting, snap a clip around the pipe,  
 press firmly against the fitting, and  
 pull the fitting off the pipe. Keep one  
 of both sizes handy!



◀ Replacement  
 PEX Bushings  
**039096**- 1/2"  
**039097**- 3/4"  
 Use with Pex tubing-  
 insert the  
 bushing inside  
 end of the Pex  
 tubing before  
 pushing Push-Fit  
 fitting onto the  
 pipe! Sold per  
 pair.



▲ Universal Transition Couplings  
 \*Works on PEX, CPVC, Polybutylene and Copper pipe!  
**039004**- 1/2" **039034**- 3/4"

Plumbing

Plumbing





# ABS/DWV PIPE AND FITTINGS



◀ **ABS/DWV Pipe- 1 1/2" Wide**

**32097**- 10' Length  
**32097-5**- 5' Length  
**32097-1**- 1' Length



▲ **33001**- 1 1/2"  
 Coupling



▲ **32301**- 1 1/2"  
 Wye



▲ **90° Elbow**  
**Regular Turn**  
**32251**- 1 1/2"  
**32253**- 3"



◀ **32501**-  
 1 1/2" 45°  
 Elbow



▲ **33051**- 1 1/2"  
 Threaded Plug



◀ **32151**-  
 1 1/2"  
 Sanitary  
 Tee

For ABS Tub/Shower plumbing see page 36. For ABS Sink plumbing see page 45. For pipe cements see page 77.

Plumbing





# BRASS FITTINGS FOR PEX TUBING



### Tees

- (read A x B x C or B x A x C)
- 24305**- 1/2" x 1/2" x 1/2"
- 24306**- 3/4" x 3/4" x 3/4"
- 24307**- 1/2" x 1/2" x 3/4"
- 24433**- 3/4" x 1/2" x 1/2"
- 24308**- 3/4" x 3/4" x 1/2"



### Couplings

- 24301**- 1/2" x 1/2"
- 24302**- 1/2" x 3/4"
- 24312**- 3/4" x 3/4"



◀ **24350**  
1/2" MPT x 3/8" MPT  
Brass Elbow



▲ **24324**  
1/2" x 1/2" FPT  
Swivel  
Elbow



### Copper Crimp Rings

- 24297**- 1/2"
- 24298**- 3/4"



◀ Male Adapters  
**24325**- 1/2" Barb x 1/2" MPT  
**24314**- 1/2" Barb x 3/4" MPT  
**24315**- 3/4" Barb x 3/4" MPT



◀ **24310**  
1/2"  
Straight  
Stop Valve



◀ Elbow  
**24303**- 1/2" x 1/2"  
**24304**- 3/4" x 3/4"

**24202** ▶  
3/4"  
Straight  
Stop  
Valve



◀ Stainless Steel  
Crimping Rings  
**24297-SS**- 1/2"  
**24298-SS**- 3/4"



◀ **24330**  
Pex 3/4" Barb x  
3/4" FPT Swivel  
Connection



◀ **24309-BR**- Faucet  
Connection Complete



◀ **24345**  
1/2" Brass  
Test Plug

**24512** ▶  
1/2" Polybutylene  
to Pex Adapter



Plumbing





# PEX TUBING

For PEX fittings see page 53.



Color/ Size	100' Roll	5' Length	10' Length	20' Length
Red 1/2"	24299-R	24299-S5R	24299-S10R	24299-SR
Blue 1/2"	24299-B	24299-S5B	24299-S10B	24299-SB
Red 3/4"	24300-R	24300-S5R	24300-S10R	24300-SR
Blue 3/4"	24300-B	24300-S5B	24300-S10B	24300-SB

Plumbing

## CPVC FITTINGS \*Discontinued\*



▲ **22313**- 12" Toilet Riser Connection- 1/2" FPT x Ballcock Thread



▲ **Faucet Riser Connections**  
1/2" FPT x 1/2" FPT  
**22320**- 12" **22321**- 20"



▲ **22305**- 1/2" Tee  
**22306**- 3/4" Tee



▲ **22314**- 1/2" Male Adapter  
**22315**- 3/4" Male Adapter



▲ **22317**- 3/4" Female Adapter



▲ **22301**- 1/2" Coupling  
**22312**- 3/4" Coupling

For ABS fittings, see page 52.

For pipe cements see page 77.





## ELECTRIC WATER HEATERS AND ACCESSORIES



### ◀ "Rheem" Double Element Water Heaters

**\*Side Connections– 1 Year Ltd Tank Warranty, 1 Year Parts Warranty**

**37135- 30 Gallon, 240V (2) 3500W**

**\*Dimensions- 46.75" High, 19" Wide**

**37145- 40 Gallon, 240V (2) 3500W**

**\*Dimensions- 50" High, 22" Wide**



◀ **02872- Flair-It 3/4" x MPT Water Heater Connection**

Plumbing

## EXTERIOR WATER HEATER DOORS

### Hinged Water Heater Doors with Camlocks ▶

Perfect for covering up that awkward water heater cubby hole on the outside of your home, keeps the water heater from escaping, and keeps those water heater-loving varmints out! Comes with pre-drilled holes for flush-mount application.

**84179- 20" x 60"**

**Non-Vented**

**84180- 23" x 60"**

**Non-Vented**

**84180-V- 23" x 60"**

**Vented for Gas Water Heaters**



White Aluminum Frame with a white smooth finish exterior skin

### Hinged Non-Vented Water Heater Doors Prepped for Lockset ▶

(Lockset not included)

**84179-H- 20" x 60"**

**84179-BH-**

**21" x 60"**

**84180-BH-**

**22" x 60"**

**84180-H- 23" x 60"**

**84180-X- 24" x 60"**

**84180-Y- 24" x 70"**



The Call Size for a water heater door is the measurement of the rough opening in the exterior wall where the entire door is installed.

For installation items, see page 10.

For water heater door locksets, see page 13.





## EXTERIOR VENTS

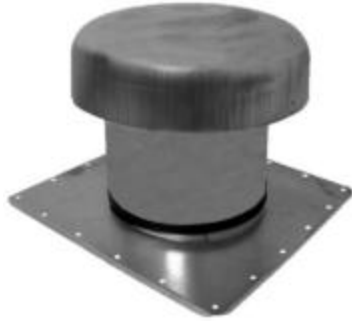

▲ Roof Vent Cap- Galvanized Steel- \*4 3/4" above roof line.  
**30080**- 5" Diameter **30082**- 7" Diameter



▲ Roof Vent Cap for Sloped Roof- Galvanized Steel 9 3/8" Down inside roof  
**30081**- 5" Width **30083**- 7" Width



▲ **38015**- Plumbing Roof Vent Cap- White Plastic \*For 1 1/2" ID pipe.



▲ **38016**- Plumbing Roof Vent Cap- Galvanized Metal \*For 1 1/4" or 2 1/2" pipe.

HVAC

Exterior Refurb

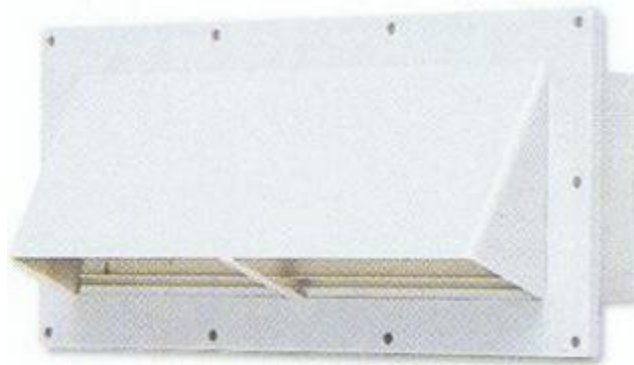

▲ **69536**- Exterior Exhaust Cover with Damper-White Plastic  
 \*Fits opening of 3 1/2" x 10 1/2"





## DUCTING SUPPLIES

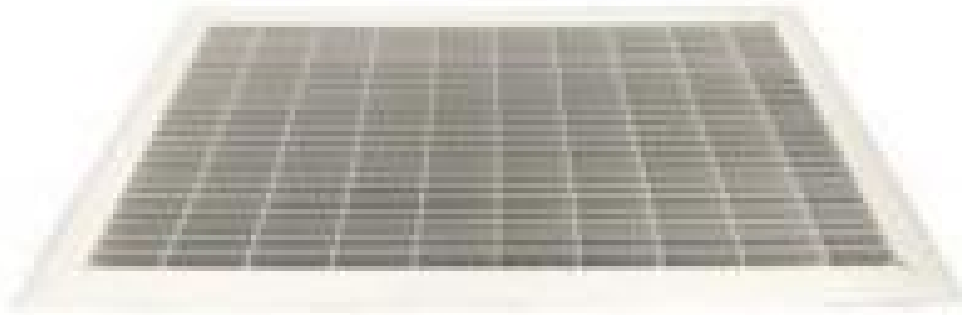

▲ Return Air Floor Grills- 12" x 20"  
**53030- Brown 53030-W- White**

HVAC



▲ **52436 - A/C Unit Foundation Pad- 36" W x 36" L x 3" H**  
\*Lightweight and sturdy, made from recycled rubber and plastic into an almost indestructible material unit! Also makes for a great sled when you turn it upside down.

For floor vents, see page 24.





# EXTERIOR ELECTRICAL SUPPLIES



▲ **50075-MD**  
LED Solar Wall  
Light-White Finish-  
3.2 Watts- 400LM



▲ **50075-LG**  
LED Exterior  
Security Light-  
White Finish- 6.8  
Watts- 800 LM



▲ **50067-W-**  
Porch Light with  
Metal Base  
Complete  
\*Comes with  
mounting  
bracket and  
screws.  
White Base



◀ **50076**  
LED Exterior  
Security Light-  
Bronze Finish

Exterior Refurb



◀ **50056-** Aluminum Cover  
Plate for GFCI Receptacle-  
with water-proof rubber  
backing.



◀ **50055-** Duplex Receptacle  
Cover- Aluminum- with  
water-proof rubber backing.

For interior light fixtures, see page 21.  
For interior receptacles, see page 20.  
For vinyl siding mounts, see page 62.



◀ **50066**  
Replacement  
Glass Jelly  
Jar Globe  
\*3 3/4"  
diameter,  
4 5/8" high,  
3 1/4" neck.





# VINYL SIDING PANELS AND SOFFIT



75 year lifetime limited warranty- Virtually maintenance free- Reinforced nail hem built to withstand winds of up to 193 miles per hour- Resists dents, hail damage, scratches and fading- Secure, positive locking system- Resistant to fungus, mildew, and wood-boring insects- authentic wood-grain finish gives the classic look of carefully painted wood without the need to paint.



**Our Dutch Lap Vinyl Siding comes in 2 different sizes, so it's important to measure! The size is determined by the height of a single lap! ▼**

The chart on this page shows the **part numbers** for siding we keep in stock. All other styles and colors are special order and have a **3-4 week lead time**. Part numbers are made from the following components;

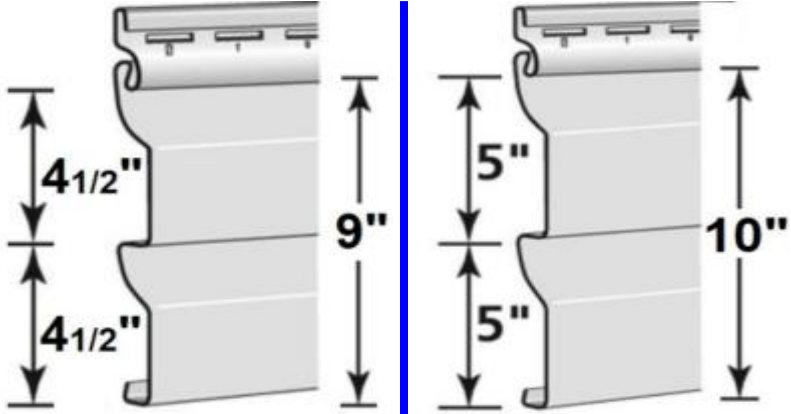

- The **first three numbers** correspond to the size, profile and quantity-
- 433- 4 1/2" Dutch-Square (11 Pcs)**
  - 434- 4 1/2" Dutch-Single Piece**
  - 435- 5" Dutch-Square (10 Pcs)**
  - 436- 5" Dutch-Single Piece**

▼ Color	4 1/2" Dutch-Square (11 Pcs)	4 1/2" Dutch-Piece	5" Dutch-Square (10 Pcs)	5" Dutch-Piece
White	43302	43402	43502	43602
Classic Sand	43311	43411	Not in stock	Not in stock
Sandalwood	43317	43417	Not in stock	Not in stock
Pebble Clay	43343	43443	Not in stock	Not in stock
Harbor Stone	43344	43444	Not in stock	Not in stock
Sunny Maize	43322	43422	Not in stock	Not in stock

- The **last two numbers** correspond to the color-
- White -02, Classic Sand -11,
  - Warm Sandalwood -17,
  - Sunny Maize -22, Summer Wheat -26,
  - Soft Willow -41, Pebble Clay -43,
  - Harbor Stone -44, Basket Beige -46,
  - Slate Blue -47, Graphite Gray -49,
  - Java -52, Artisan Clay -61,
  - Seagrass -79, Meadow -82,
  - Nutmeg -86

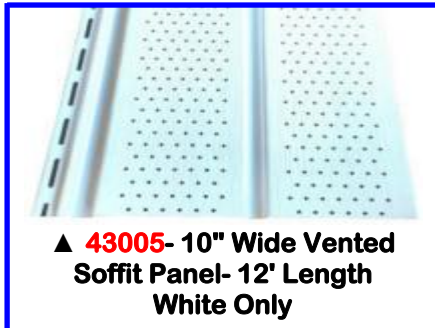

◀ **70297- Vinyl Siding Removal Tool**

For vinyl siding trim and mounts, see next page.

Exterior Refurb





# VINYL SIDING TRIM AND MOUNTS



◀ 3" Vinyl  
Outside Corner  
Post- 10' Length  
**43010- White**  
For part numbers to  
other colors see box  
at lower left.



◀ 5/8" Vinyl  
J-Channel-  
12' Length

**43015- White**  
For part numbers to other colors see box at lower left.

1 3/8" Inside  
Corner Post-10'  
Length ▶  
**43009- White**

For part numbers to other colors see  
box at lower left.



◀ **43017- 3/4"**  
Non-Flexible Vinyl  
"Super" J-Channel- 12'  
Length- White Only



◀ Vinyl Under-Sill Trim-  
12' Length  
**43025- White**  
For part numbers to other  
colors see box at lower left.



◀ **43029**  
Snap-In Crown  
Molding Trim-  
12' Length-  
White only



◀ **43027- F-Channel-**  
12' Length- White only  
\*For trimming out soffit panels  
(see previous page).  
For part numbers to other  
colors see box at lower left.

**43020- Aluminum**  
Starter Strip-  
10' Length ▶



◀ **43028- Retaining**  
Trim for Snap-In  
Crown Molding-  
12' Length- White  
only



◀ **43018- 1 1/2"**  
Vinyl Door/ Window  
Molding- 8' Length-  
White Only



▲ Vinyl Mount for  
Exterior Light  
Fixture-  
**43061- White**  
**43061-HS- Harbor**  
Stone  
**43061-SW-**  
Sandalwood

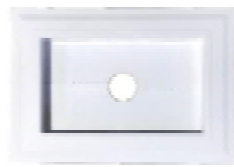

▲ Vinyl Mount for  
Exterior  
Receptacle-  
**43060- White**  
**43060-HS- Harbor**  
Stone  
**43060-SW-**  
Sandalwood



◀ **43030**  
6 1/2" Fascia  
Trim  
\*10' Length- White  
only

For any color other than white, add one of the  
following suffixes to the part number-  
Classic Sand -11, Warm Sandalwood -17, Sunny  
Maize -22, Summer Wheat -26, Soft Willow -41,  
Pebble Clay -43, Harbor Stone -44, Basket Beige -  
46, Slate Blue -47, Graphite Gray -49, Java -52,  
Artisan Clay -61, Seagrass -79, Meadow -82,  
Nutmeg -86

\*Example- **43010-47** Outside Corner in Slate Blue

Exterior  
Refurb

For dryer vent covers, see page 56.





# ROOF REPAIR ITEMS



▲ **48011-** Aluminum Drip Rail- \*1 1/2" Tall Back Flange, 1/2" Wide Channel, 1/2" Tall Front Wall  
 \*14' Length- sturdy, fabricated drip rail with beaded mill finish. For use with steel roofs. Each piece has 35 holes for screws.



▲ **48012-** Jumbo Aluminum Drip Rail- \*1 1/2" Tall Back Flange, 7/8" Wide Channel, 5/8" Tall Front Wall  
 \*12' Length- sturdy, fabricated drip rail with beaded mill finish. For use with steel roofs. Each piece has 35 holes for screws.



◀ **40005-** White Premium Roof Coating- 4.75 Gallon Pail  
 \*White. 5 Year Warranty - 100% Acrylic, Elastomeric, Insulating Ceramic, waterproof coating. Covers approximately 150 square feet per gallon. Use with a paint brush or paint roller.

## "Peel-N-Seal" Roof Patch

For quick waterproof repairs- Self-sticking- 45 mil asphalt backing- 10 Year Limited Warranty- Use to patch roofs, gutters, and other exterior areas- reflects heat and keeps you cooler!

**85100-W-** 12" x 33.5' White (box of 3 rolls)

**85101-** 18" x 33.5' Aluminum (box of 2 rolls)

**85101-W-** 18" x 33.5' White (box of 2 rolls)



White

Aluminum

▼ **Steel Mini-Gutter Rail**  
 \*Discontinued items with select availabilities.

For use with most mobile home roofs. Dimensions- Back wall is 2 13/16" tall, front wall is 1 9/16" tall. 1 3/4" width at the top, 3/4" width at the bottom. Smaller than the standard gutters you may see on "foundation" homes.

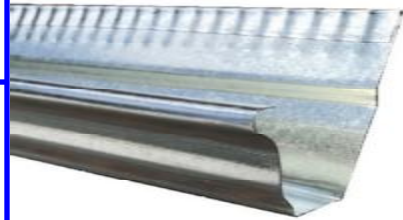

▲ **99105-G** 10' Length- Galvanized Steel



▲ **99105-C** 12' Length- Cream



▲ **99105-C** 12' Length- White



◀ **10599-** 10" x 50' Roll- Galvanized Steel Flashing \*28 gauge steel.

Exterior Refurb





# UNDER-THE-HOME REPAIR ITEMS

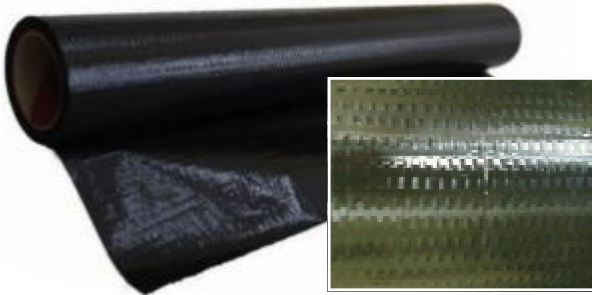

## ▲ Pre-Cut Plastic Belly Material

\*Folded and boxed for your convenience.

**99501**- 14' wide x 70' long

**99502**- 16' wide x 80' long

**99503**- 30" wide x 100' long (roll)

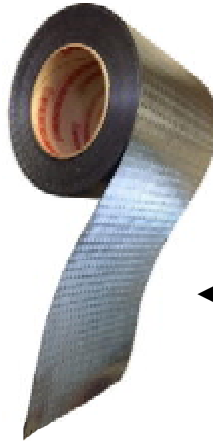

## Flex Mend Belly Repair Tape

\*Solid coated fabric with adhesive back. Perfect for underbelly repair.

◀ **99518**- 2" x 180' Roll

**99519**- 4" x 180' Roll

**99520**- 6" x 180' Roll

**99525**- 28" x 25' Roll



## ▲ **99530**- Flex Mend Trap Flap

(18" x 18" Overall with 12" x 15" rough opening)

\*A fabric access panel for plumbing- Built-in U-shaped zipper makes it really easy to access "hot spots" under the home.



▲ **99535**- Flex Mend Zip Strip (6" x 72"). A strip of Flex-Mend with a zipper built-in.



## Adjustable Outrigger Joist Support

▲ **16014**- for 14'/ 28' Wide Homes

**16016**- for 16' Wide Homes

\*Designed for added support under doorways and large windows, or perhaps where heavy furniture or people are positioned near the outer wall of your home, replacing perimeter blocking. Sold in pairs.



## ◀ **85002**- Black Belly Tape

\*2" x 60 yd. roll For use in applying, attaching, or repairing belly paper.

For set-up and leveling items, see page 81.

Exterior Refurb





# "STYLE-CREST" ECONOMY VINYL SKIRTING



## Vented Panels ▲

**70330-E- White 70304-E- Sand 70350-E- Grey**

\*Carton Quantity: 12 pieces. Panels are 140" Tall x 16" Wide. Panels can be sold singularly or by the carton



## ▲ Trim Kits

\*Includes 15 pieces each of Top Back, Top Front, and Ground Channel. Ground Spikes and screws not included. Enough trim to cover up to 165 lineal feet.

**70380-E- Grey 70360-E- White  
70400-E- Sand**

## Top Front Rail- 11' Length

**70346-E- Grey  
70356-E- White  
70402-E- Sand**



Snaps in ground channel, provides extra 4" of protection from weed trimmers- 11' length.



**70346- Grey  
70356- White  
70402- Sand**

## Solid Panels ►

**70304-ES- Sand  
70309-E- Grey  
70310-E- White**



## Top Back Rail- 11' Length



**70345-E- Grey  
70355-E- White  
70401-E- Sand**

**Weed-Eater Guard**  
(It's actually a Top Front Rail upside-down, but it works!) ▼



▲ **Ground Channel-11' length**  
**70347-E- Grey  
70357-E- White  
70403-E- Sand**

Exterior Refurb

For more skirting items see page 74.  
For a usage chart, see page 67.  
For screws, see page 77.





# "STYLE-CREST" LIFETIME VINYL SKIRTING

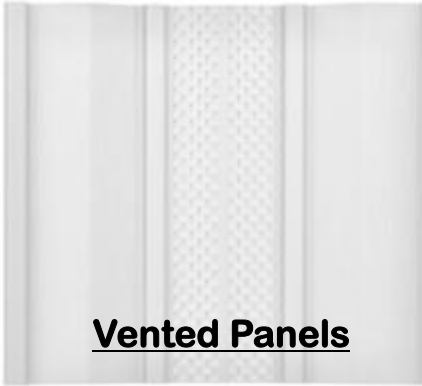

**Vented Panels**

## Lifetime Vinyl Panels

\*Carton Quantity: 12 pieces. Panels are 140" Tall x 16" Wide. Panels can be sold singularly or by the carton!

- ◀ **70304- Sand 70307- Tan 70350- Light Grey**  
**70330- White 70320- Clay 70415- Chocolate**  
**70435- Charcoal Grey**



**Solid Panels**



## ▲ Trim Kits

\*Includes 15 pieces each of Top Back, Top Front, and Ground Channel. Ground Spikes and screws not included. Enough trim to cover up to 165 lineal feet.

- 70322- Clay 70360- White**  
**70380- Light Grey 70390- Tan**  
**70400- Sand 70420- Chocolate**  
**70440- Charcoal Grey 70460- Dove**

- ▲ **70303- Sand 70306- Tan**  
**70309- Light Grey 70310- White**  
**70319- Clay 70410- Chocolate**  
**70430- Charcoal Grey**

## Top Front Rail- 11' Length

- 70326- Clay**  
**70356- White**  
**70346- Light Grey**  
**70376- Tan**  
**70402- Sand**  
**70422- Chocolate**  
**70442- Charcoal Grey**  
**70466- Dove**



## Top Back Rail- 11' Length

- 70325- Clay**  
**70345- Light Grey**  
**70355- White**  
**70375- Tan**  
**70401- Sand**  
**70421- Chocolate**  
**70441- Charcoal Grey**  
**70465- Dove**



▲ **Weed-Eater Guard ▶**  
 (It's actually a Top Front Rail  
 Upside-Down.) Snaps in  
 ground channel, provides  
 extra 4" of protection from  
 weed trimmers- 11' length.



## Ground Channel- 11' Length

- 70327- Clay 70357- White**  
**70377- Tan 70403- Sand**  
**70347- Light Grey**  
**70423- Chocolate**  
**70443- Charcoal Grey**  
**70467- Dove**

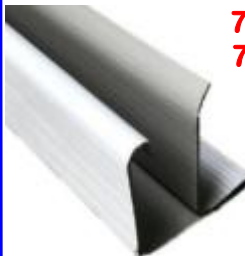

Exterior  
Refurb

For more skirting items see page 74.  
 For a usage chart, see page 67.  
 For screws, see page 77.





# CALCULATING VINYL SKIRTING KITS

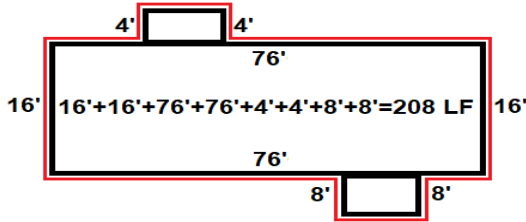

◀ To cover the entire home, measure all four sides. For a 16' wide x 76' long house the 4 sides will total up to 184 lineal feet (LF). If you have to skirt a deck, add the sides coming away from the home to the total lineal footage. Normally, if you skirt around your deck, you don't have to skirt *behind* the deck. The red line indicates where your skirting will be installed.

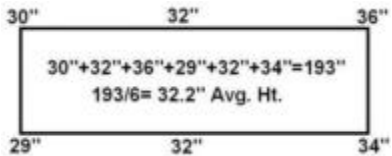

$208' / 11' = 18.9$   
18.9 rounds up to 19 trim pieces

◀ To calculate vinyl trim, divide the total LF by 11. All skirting trim pieces are 11' long.

▲ Take a height measurement at each of the four corners of the home and the mid-point of each long side, total up the measurements, and divide by 6. This will determine the average height of your cut panels.

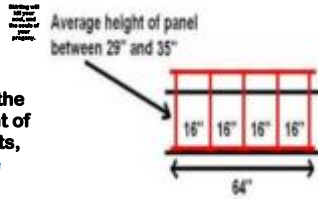

Knowing the average height helps to determine how many full panels will be needed. Most homes have average heights between 29" and 35". A full panel, when cut into 4 smaller panels and installed, will cover 5.33 LF. To calculate the total number of full panels you will need, use this handy formula: **Total lineal feet times .75 divided by "x"** ("x" is the number of cuts you can get from a full panel, according to the average height)

Based on box size lineal footage (LF). Panel quantities change with height variations. Pick the panel column that reflects your average height. Determine average height with several measurements from ground to 1"- 2" overlap on siding. Consult our skirting representative for special quotes.

Box Size (LF) ▼	Panels up to 28" Avg. Ht.	Panels up to 35" Avg. Ht.	Panels up to 46" Avg. Ht.	Trim Kit (165 LF)	Top Back Trim	Top Front Trim	Ground Channel	Weed-Eater Guard	Hex Screws	7" Ground Spikes
14 x 36 (100)	15	19	25	-	10	10	10	10	300	70
12 x 56 (136)	21	26	34	-	13	13	13	13	400	90
14 x 56 (140)	21	27	35	-	13	13	13	13	400	90
16 x 56 (144)	22	27	36	-	14	14	14	14	500	100
32 x 42 (148)	23	28	37	-	14	14	14	14	500	100
28 x 48 (152)	23	29	38	-	14	14	14	14	500	100
28 x 52 (160)	24	30	40	1	-	-	-	15	500	100
28 x 56 (168)	26	32	42	1	1	1	1	16	500	110
28 x 60 (176)	27	33	44	1	1	1	1	16	500	110
16 x 76 (184)	28	35	46	1	2	2	2	17	500	115
18 x 76 (188)	29	36	47	1	3	3	3	18	500	120
28 x 68 (192)	29	36	48	1	3	3	3	18	500	125
32 x 66 (196)	30	37	49	1	3	3	3	18	500	125
28 x 72 (200)	30	38	50	1	4	4	4	19	500	130
28 x 76 (208)	32	39	52	1	4	4	4	19	500	130
32 x 76 (216)	33	41	54	1	5	5	5	20	600	135

## Helpful Notes:

\*To determine average height, measure from ground to bottom of home siding at each corner and middle of long sides, add up all measurements and divide by total number of measurements, then add 1 inch. (Example: 30 + 34 + 29 + 27 + 32 + 30 = 182 inches, divided by 6 measurements = 30.33 inches, plus 1 inch = 31.33 average height.) This will determine how many cuts you can get from a full panel, and how many panels you will need. A full 140" panel will yield (3) 46.6" cuts, (4) 35" cuts, or (5) 28" cuts.

\*Trim Kits Contain (15) Top Back, (15) Top Front, (15) Ground Channel, enough trim to cover 165 lineal feet. Use 7-8 Ground Spikes per channel.

\*Panels taller than 48" require interior bracing. We recommend using steel "J" ground channel and/or wind-guard rods for bracing.  
\*Decks require extra materials. For decks, add the lengths of the two sides running away from the home to total lineal feet, and refer to chart. To cover a hitch, add 8 feet to total lineal feet. (1) steel ground channel and (1) steel corner piece are recommended for bracing and covering one hitch. For sturdier hitch covers, use wood bracing.  
\*Lifetime Top Front trim can be combined with ground channel for added protection from weed trimmers. \*Homes on inclines will use extra ground channel. Sloped walk ramps and sides of steps will use extra top trim.

Exterior Refurb





# EXTERIOR STEEL TRIM

## "MetalMax" Steel Top Trim / Cap



10' 6" Length. 29 gauge steel. Use to cover top of panel. Mounting flange height is 3/4" high, breaks away 1", Face height is 2.5". Overall height- 3.5".

- 49230- Black**
- 49231- Brown**
- 49232- Charcoal**

## "MetalMax" Steel Ground Channel



10' 6" Length. 29 gauge steel. Panel sits inside this track. Front wall is 2" height, back wall is 1" height. Channel width is 1.25".

- 49240- Black**
- 49241- Brown**
- 49242- Charcoal**

## "MetalMax" Steel Corner ▶

10' 6" Length. 29 gauge steel. 3" Width. Use to cover corners.

- 49230- Black**
- 49231- Brown**
- 49232- Charcoal**

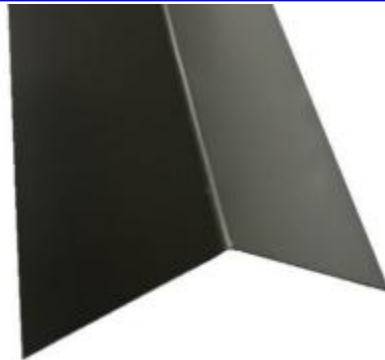

**48076- 6 1/4" Wide Steel Fascia-10' Length- White only**

## "Amerimax" Steel Outside Corner

**\*Discontinued Items- Limited Availability**



- 9' Length**
- 48074- White**
- 48034- Medium Brown**
- 48054- Dark Grey**
- 48064- Taupe**
- 48084- Black**
- 48094- Tan**
- 48104- Sage**

## ▼ Steel Mini-Gutter Rail ▼

Dimensions- Back wall is 2 13/16" tall, front wall is 1 9/16" tall. 1 3/4" width at the top, 3/4" width at the bottom.



◀ **99105-G**  
10' Length- Galvanized Steel



◀ 12' Length Steel Mini-Gutter  
**99105-W- White**  
**99105-C- Cream**  
**99105-B- Dark Brown**

Exterior Refurb

For ground spikes and tin snips see page 74.  
For screws see page 77.

For sealants and fasteners, see page 77.





# "MASON" ARTIFICIAL ROCK SKIRTING



\*Beautifully designed for enduring curb appeal- **Authentic look**- Compliments all home styles- Made in the USA - **5 Year Limited Warranty**- Choose from three realistic colors.

## Mason Rock Panels

\*ABS Plastic composition- **Pre-trimmed** for a "seamless" look- Cut with tin snips, carpet knife, or fine tooth saw blade for elevation- **Requires ventilation**- Easy to bend around corners using heat gun or torch, or corner pieces can be used to cap two panels merging- **Bracing should be installed behind panels over 48" tall**- Screws must be used to attach panels where overlapped- Insulation may be added in colder climates.



## Skirting Access Doors

For emergency trips to the water cut-off and easy access to receptacles under home- **Comes with two keys**- Works well with any kind of skirting!

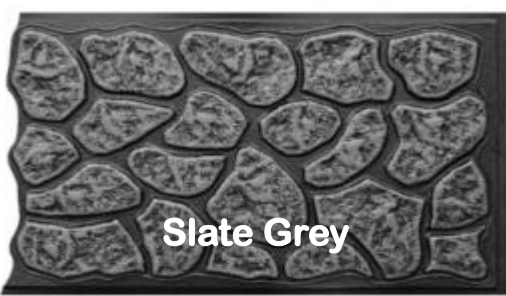

Slate Grey

**49160- 32" x 60"** **49161- 36" x 60"**  
**49162- 48" x 60"**



▲ **49155- Black**

\*Over-all size- 30" wide x 22.75" tall



▲ **49057- White**

\*Over-all size- 32" wide x 24" tall

Exterior Refurb

## Automatic Foundation Vent Inserts

\*Automatically opens and closes at 70/40 degrees Fahrenheit (approx.)- **Helps defend against crawl space moisture and foundation decay**- Lowers risk of frozen pipes- **Screened to deter insects and rodents**- Overall dimensions- 17 1/4" W x 9 3/4" H



◀ **49080- Black**  
**49080-W- White**  
**49082- Brown**  
**49083- Grey**



Sedona Brown

**49150- 32" x 60"** **49151- 36" x 60"**  
**49152- 48" x 60"**

## Manual Foundation Vent Inserts

Vent inserts measure 16 1/2" wide x 9 1/2" tall- **Fitted with screen**- Inserts over a pre-cut hole in a panel of 15 1/4" wide x 8" tall. **One vent placed every 10-15 feet is recommended.**



◀ **49054- Black**  
**49054-W- White**  
**49055- Brown**



Tuscan Tan

**49170- 32" x 60"** **49171- 36" x 60"**  
**49172- 48" x 60"**

## Passive Foundation Vent Inserts

For skirting ventilation- **Helps defend against crawl space moisture and foundation decay**- Screened to deter insects and rodents- **Overall dimensions- 16 7/8" wide x 9 1/2" tall- Fits into a 15 1/4" wide x 8" opening**- One vent installed every 100 square feet of space under the home is recommended. Use more or less at your discretion.



◀ **49054-W-ECO- White**  
**49054-ECO- Black**  
**49054-BR-ECO- Brown**

For a usage chart, see page 72.  
For steel trim see page 69.

For ground spikes, see page 74.  
For screws, see page 77.





# "MASON" ARTIFICIAL BRICK SKIRTING



**\*Attractive, easy to install brick pattern foundation cover- Vacuum formed panels composed of durable hard milled, 0.60 mil thickness ABS plastic- Weed-eater "proof"- won't scratch or dent- Panel is surrounded by 1" flange for easy mounting- An affordable alternative to natural brick or concrete enclosure- 5 Year Limited Warranty- Choose from two realistic colors.**



▲ Panels overlap in a "finger-joint" fashion and can be connected with either grout or hex screws.



▲ When the panels join together they give a seamless look of continuity.



▲ Panels can be bent around corners with a heat gun, but we also offer steel corners if you don't want to bend the panel! [Steel corners are featured on page 75.](#)



▲ The backside of each brick panel is reinforced with two vertical structural supports.

## Mason Brick Panels



**Brown Bricks on Tan Grout**

**493361- 36" x 60" 493481- 48" x 60"**



**Red Bricks on Tan Grout**

**493362- 36" x 60" 493482- 48" x 60"**

## Mason Dentil Trim



◀ Our dentil trim is an optional way to cap off your beautiful brick skirting- **True coverage is 4 feet, 9 inches-** It can work as a top trim by itself, but it's designed to work best with a vinyl top back trim. [To see all the options we offer for top trim, bottom track, and corners please go to page 75.](#)



◀ Pictured here- **Red Brick Panels with Brown Dentil Trim** combined with **Chocolate Top Back Trim.**



▲ **49411- Brown Dentil Trim- 5' Length**



▲ **49412- Brown Dentil Trim- 5' Length**

**Exterior Refurb**

For a usage chart, see page 72.  
For steel trim see page 71.

For ground spikes, see page 74.  
For screws, see page 77.





# TRIM FOR ROCK AND BRICK SKIRTING

We offer several options for customizing your own unique rock and brick enclosure! No one way is correct- make it just the way you want it!

## "MetalMax" Steel Top Trim / Cap



10' 6" Length. 29 gauge steel. Use to cover top of panel. Mounting flange height 3/4" tall, breaks away 1" wide, face height 2.5" tall. Overall height- 3.5".

- 49230- Black
- 49231- Brown
- 49232- Charcoal

## "MetalMax" Steel Ground Channel



10' 6" Length. 29 gauge steel. Panel sits inside this track. Front wall 2" tall, back wall 1" tall. Floor is 1.25" wide. Specifically designed for thick rock and brick panels.

- 49240- Black
- 49241- Brown
- 49242- Charcoal

## "MetalMax" Steel Corner ▼

10' 6" Length. 29 gauge steel. 3" Width. Use to cover corners where two panels converge.



- 49230- Black
- 49231- Brown
- 49232- Charcoal

## Vinyl Top Back Trim

11' length. Use with matching top front trim for rock or brick panels or with dentil trim for brick panels. (See page 70).



- 70325- Clay
- 70345- Light Grey
- 70355- White
- 70375- Tan
- 70401- Sand
- 70421- Chocolate
- 70441- Charcoal Grey

## Vinyl Top Front Trim

11' length. Use with matching vinyl top back for either rock or brick panels.



- 70326- Clay
- 70346- Light Grey
- 70356- White
- 70376- Tan
- 70402- Sand
- 70422- Chocolate
- 70442- Charcoal Grey

## "Amerimax" Steel Ground Channel

Discontinued Items- Limited Availability

\*10'Length- Dimensions- Front wall 2.5" tall, Back wall 1.5" tall, Floor 1 3/8" wide- Specifically designed for thick rock and brick panels. For ground spikes see page 74.



- ◀ 49270- Taupe- 10' Length
- Matches Tuscan Tan rock panels and the mortar of the brick panels

## Vinyl Ground Channel

11' length- It's a tight fit for rock panels, but they fit brick panels nicely- Use with matching top back and top front vinyl trim. For ground spikes see page 77.



- 70327- Clay
- 70357- White
- 70347- Light Grey
- 70377- Tan
- 70403- Sand
- 70423- Chocolate
- 70443- Charcoal Grey

## "Amerimax" 3" Wide Steel Outside Corner- 9' Length ▶

Discontinued Items- Limited Availability

- 48024- Dark Brown
- 48074- White
- 48034- Medium Brown
- 48054- Dark Grey
- 48064- Taupe
- 48084- Black
- 48094- Tan



For hex screws with colored heads (Black, White, and Tan) that can be used to connect rock and brick panels and blend in with the background, please see page 77.

For foundation vents and access doors see page 69.

To calculate how the materials you will need for rock or brick skirting for your home, see page 72.

Exterior Refurb





## CALCULATING ROCK AND BRICK SKIRTING USAGE

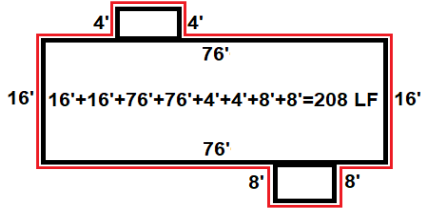

◀ It is important to know first how many lineal feet (or LF) you have to calculate what components you will need. **For an entire home, LF is the total perimeter, adding up all the sides including any porches or decks.** The red line indicates where your skirting will be installed.



◀ The true coverage of each panel is roughly 58.5". To calculate the total number of panels, use this handy formula: **LF times 12 divided by 58.5 = Total number of panels needed.** Example:  $(184 \text{ LF} \times 12) / 58.5 = 37.7$ , which rounds up to 38 panels.



Use a yardstick to measure from the ground up to the very bottom of the home's outside wall. This will tell you how tall the panel needs to be. Because there are different heights of panels, you'll need to find out how many of each size you need. Take a height measurement every 5 feet and mark them down on a diagram of the house. ▶

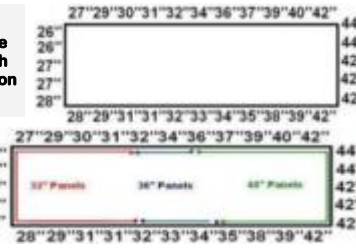

▲ If you use foundation vents, we recommend one vent placed every 10-15 LF. Vents are best installed in the middle of a panel, so plan your spread carefully for an even overall look.

Now make "zones" for each size of panel, which will determine how many running feet will use 32", 36", and 48" panels. The quantities of each size should add up to the total number of panel you calculated earlier. Add an extra panel "just in case"! ▶

Calculating trim is easy. For 10.5 ft. length steel top trim and ground channel, divide the total LF by 10.5. For 11 ft. length vinyl top back, top front and ground channel, divide the total LF by 11. For 5 ft. length dentil trim, divide the total LF by 5.



◀ You will need hex head screws to attach the panels to the home, the ground channel and the adjacent panels. A good formula for figuring the amount of screws needed is-  $\text{LF} \times 3.75 = \text{Total number of screws}$

▲ 5-7 ground spikes per piece of ground channel is recommended, but you may need more for sandy soil. For going over concrete, use 1 tube of liquid adhesive (Page 77) per 15 LF.

## ROCK AND BRICK SKIRTING USAGE CHART

This chart shows the piece counts needed for several standard sizes of mobile homes. For other amounts of lineal footage, please extrapolate. Panel counts are based on average heights of 32" - 48". Chart does not include access doors (Page 69), which are installed inside a panel as many places as you want, or steel corners which depend on the number of corners and the heights of those corners (Page 71). These are estimates only!

Box Size (LF) ▼	Rock Panels (Page 69) or Brick Panels (Page 70)	10' 6" Steel Top Trim and Ground Channel (Page 71)	11' Vinyl Top Back, Top Front and Bottom Trim (Page 71)	5' Brick Dentil Trim -Works with Vinyl Top Back (Page 70)	Foundation Vents (Page 69)	Total Hex Screws-Colors may be mixed (Page 77)	Ground Spikes (Page 74)
16 x 56 (144)	31	14	14	30	14	540	90
32 x 42 (148)	32	15	14	32	14	555	96
28 x 48 (152)	33	15	15	32	16	570	96
28 x 52 (160)	34	16	15	34	16	600	102
28 x 56 (168)	36	17	16	36	16	630	108
28 x 60 (176)	37	17	17	36	18	660	108
16 x 76 (184)	39	18	17	38	18	690	114
28 x 68 (192)	41	19	18	40	20	720	120
32 x 66 (196)	42	19	19	40	20	735	120
28 x 72 (200)	43	20	19	42	20	750	126
28 x 76 (208)	44	20	20	44	22	780	132
32 x 76 (216)	46	21	21	44	22	810	132

Exterior Refurb





# "TITAN PRIME" HEAVY-DUTY VINYL SKIRTING



Our hardest, sleekest, most durable vinyl skirting

"Titan Xterior Prime" is a foundation cover uniquely engineered to withstand the ongoing rigors of lawn trimming and child's play, as well as mother nature- **Covered by a Limited 5-Year "No Holes" Warranty**- Sleek, classic lines add simple beauty to your home with the realistic appearance of poured concrete or stucco foundations- **Our exclusive, 5/8" thick, reinforced vinyl panel design is one flat exterior panel backed by an interior panel girded with vertical rigid ribs, offering superior protection from high winds, frost heaving, and hail**- Installs as easily as other types of vinyl skirting with minimal installation time, using traditional foundation vents and standard vinyl skirting accessories.



The backside of three panels put together- the vertical ribs add stability against wind.



▲ Resists damage due to lawn care accidents



▲ Realistic appearance of stucco or poured concrete

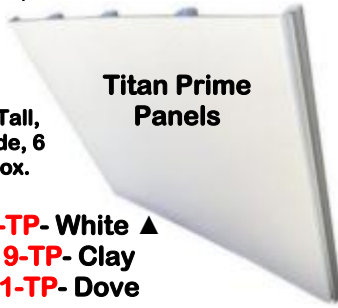

Titan Prime Panels

\*144" Tall, 16" Wide, 6 to a box.

**70310-TP- White** ▲  
**70319-TP- Clay**  
**70461-TP- Dove**



▲ **Corner Kits for Titan Prime**  
\*4 Corners to a kit (Panels do not bend around corners, you have to cap them!)



▲ Titan Prime Panels are used with Lifetime Vinyl Skirting Trim (see corresponding colors on page 66). Use foundation vents (see page 69) for ventilation.

**70360-CK- White 70322-CK- Clay 70460-CK- Dove**

Exterior Refurb

## "TITAN" PRIME SKIRTING USAGE CHART

This chart shows the piece counts needed for several standard sizes of mobile homes. For other amounts of lineal footage, please extrapolate. Panel counts are based on 3 different average heights. Chart does not include access doors (Page 69), which are installed inside a panel as many places as you want. These are estimates only!

To calculate the total number of full panels (it's the same for either vented panels or solid panels) you will need, use this handy formula: **Total lineal feet times .75 divided by "x"** ("x" is the number of cuts you can get from a full panel, according to the average height) Example for 29"- 35" Avg. Ht.: **LF x .75 divided by 4= # of panels (184 LF X .75)/4= 34.5 (Rounds up to 35 panels)**

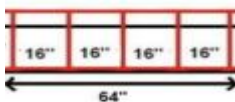

▲ One panel cut down into quarters covers 5.3 lineal feet.

Box Size (LF) ▼	Panels up to 29" Avg. Ht.	Panels up to 36" Avg. Ht.	Panels up to 48" Avg. Ht.	Trim Kit (166 LF)	Top Back Trim	Top Front Trim	Ground Channel	Hex Screws	7" Ground Spikes
28 x 52 (160)	24	30	40	1	-	-	-	500	100
28 x 56 (168)	26	32	42	1	1	1	1	500	110
28 x 60 (176)	27	33	44	1	1	1	1	500	110
16 x 76 (184)	28	35	46	1	2	2	2	500	115
18 x 76 (188)	29	36	47	1	3	3	3	500	120
28 x 68 (192)	29	36	48	1	3	3	3	500	125
32 x 66 (196)	30	37	49	1	3	3	3	500	125
28 x 72 (200)	30	38	50	1	4	4	4	500	130
28 x 76 (208)	32	39	52	1	4	4	4	500	130
32 x 76 (216)	33	41	54	1	5	5	5	600	135

For skirting tools and spikes, see next page.  
For screws see page 77.





# SKIRTING ACCESSORIES



**▲ 48211**  
**7" Ground Spikes**  
 \*7 spikes per vinyl ground channel or 6 spikes per steel "J" channel for firm soil is recommended. Spikes used will vary depending on soil type.



## Wind Stay Rods

\*For use with vinyl skirting. Allows panel to expand and contract with seasonal changes. 1 rod for every 3-4 panels recommended. Use more frequently for taller panels or windy areas, or upgrade to 24" rods.

◀ **70000**- 12" Length \*For panels up to 36" tall  
**70001**- 24" Length \*For panels 36" and taller



▲ Step 1: Insert stay rod inside the S-lock of two joined panels.



▲ Step 2: Insert stay rod head inside the rib of the top back trim. The top front trim is installed next.



**▲ 70294**- M12 Tin Snips  
 \*For cutting panels and trim. Easy to use and durable. 12" length.



## ◀ 70005- Steel Mounting Bracket for Vinyl Skirting Top Trim

Made of galvanized steel and designed for use on homes where top trim cannot be attached to the siding. Mounts to wood joist and provides solid backing for installation of Lifetime or Economy Top Back Trim- Conforms with HUD Code 3285.504.



**▲ 70295**- M14 Tin Snips  
 \*Larger snips with more leverage, the preferred snips for all types of skirting. 14" length.



## ▲ 70299- SL 5 Model Punch Tool (Standard)

\*For use with Vinyl Panels. 4 punches per panel is recommended.

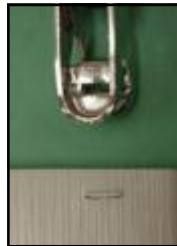

**▲ All-Purpose Nylon Zip Ties**

Length/Qty ▶	8" (100/pk)	11" (100/pk)	18" (100/pk)
White	<b>48408</b>	<b>48411</b>	<b>48418</b>
Black	<b>48508</b>	<b>48511</b>	<b>48518</b>

Exterior Refurb

For more fasteners, see page 77.





# "STYLE-CREST" FIBERGLASS STEPS



**Beauty-** Complementary color blends well with any mobile home exterior.  
**Stability-** Most styles are completely enclosed and feature generous 12" treads with skid-resistant surface.  
**Durability-** Constructed of reinforced pressure treated plywood, 2' x 4's and 2' x 2's, and completely covered with a pressure-laminated fiberglass "jacket".



(Closer view of our Fiberglass Steps)

**Economy-** Virtually maintenance-free. No need to worry about rusting, as with metal steps.  
**Our steps are virtually indestructible, unaffected by salt and easily hosed clean.**



## ◀ 36" Wide Step with 24" Deep Landing

\*Safe, attractive, and practical. All 36" models have a 24" landing.

## ◀ 48" Wide Step with 29" Deep Landing

\*A popular mid-sized step with a deeper platform. All 48" step models have a full 29" landing.

Each step/ tread is 12" deep for added safety. Handrails sold separately. Used primarily as a straight-away front entry step.

## 38" Wide or 48" Wide with 38" Deep Landing Side-Approach Step ▶

Use this full back step with for a parallel or front approach. Rails are reversible. Ideal for when a straight entry is not feasible. This step is closed on the back side.

Pictured with Handrail and Back Rail. BOCA, OSHA, and code approved in most areas.



Exterior Refurb



## ◀ 72" Twin Step

A big approach with full 72" wide step and 29" deep platform. Each step/tread is 12" deep for added safety. For use with sliding glass and atrium doors. Twin hand rails recommended.

For handrails and back rails see next page.

Landing Size ▼	21" Height	24" Height	28" Height	32" Height	35" Height	40" Height	42" Height
36" Wide x 24" Deep	021121	021124	021128	021132	021135	021140	021142
38" Wide x 38" Deep	021321	021324	021328	021332	021335	021340	021342
48" Wide x 38" Deep	021521	021524	021528	021532	021535	021540	021542
48" Wide x 29" Deep	021621	021624	021628	021632	021635	021640	N/A
72" Wide x 29" Deep	021821	021824	021828	021832	021835	021840	N/A





## "STYLE-CREST" FIBERGLASS STEP RAILINGS



Handrails and Back Rails shown here with side approach steps. ▶



Our Handrails and Back Rails are welded aluminum and are custom-made to be bolted to the pre-drilled holes in our fiberglass steps (See previous page).  
**Mounting hardware included.**  
 Meets or exceeds most OSHA and BOCA standards. Railings on both sides for straight-away steps are recommended for added looks and safety. See part number chart below. **Special order only!**



▲ Back Rails for Side Approach Steps with Enclosed Backs  
**021400-** For 38" Wide Steps  
**021410-** For 48" Wide Steps

\*Mounting hardware included.



Landing Size ▼	21" Height	24" Height	28" Height	32" Height	35" Height	40" Height	42" Height
36" Wide x 24" Deep	<b>021221</b>	<b>021221</b>	<b>021228</b>	<b>021228</b>	<b>021235</b>	<b>021240</b>	<b>021242</b>
38" Wide x 38" Deep	<b>021421</b>	<b>021421</b>	<b>021428</b>	<b>021428</b>	<b>021435</b>	<b>021440</b>	<b>021442</b>
48" Wide x 38" Deep	<b>021421</b>	<b>021421</b>	<b>021428</b>	<b>021428</b>	<b>021435</b>	<b>021440</b>	<b>021442</b>
48" Wide x 29" Deep	<b>021721</b>	<b>021721</b>	<b>021728</b>	<b>021728</b>	<b>021735</b>	<b>021740</b>	N/A
72" Wide x 29" Deep	<b>021721</b>	<b>021721</b>	<b>021728</b>	<b>021728</b>	<b>021735</b>	<b>021740</b>	N/A

Exterior Refurb

## TEMPORARY WOOD STEPS AND RAILINGS



### ◀ **02262-** "Ott" Wood Step with Steel Handrail

\*37" Long x 37" Wide x 32" Tall- Four treaded steps attached to a steel black frame. No platform. Handrails can be attached to both or either side (Extra handrail sold separately) Hardware includes 4 short bolts, 4 long bolts, 8 nuts, 4 spacers. Some assembly required.

**All steps must ship by freight unless you can pick it up here!**

**\*WARNING\*- Wooden Steps are for temporary use only!**





# HEX HEAD SCREWS

Used to install skirting, doors, windows, and more! We can help you determine how many you will need- most doors use 60 screws, windows use 12- 60 screws depending on the size. Screws designed for skirting are bagged in 250 and 500 count quantities. \*For box quantities, add **-BX** to the **part number!** (Note: Box quantities are several thousands, but we are happy to sell you any quantity you need, just tell us!)



We also offer screws with colored heads to match our doors and windows, and vinyl, steel, rock and brick skirting!

▼ Size	Mill	Tan	Black	White	Cream
8 x 3/4"	<b>48203</b>	N/A	<b>48203-BLK</b>	N/A	N/A
8 x 1"	<b>48207</b>	<b>48207-TAN</b>	<b>48207-BLK</b>	<b>48207-W</b>	<b>48207-C</b>
8 x 1 1/4"	<b>48208</b>	N/A	N/A	<b>48208-W</b>	N/A
8 x 1 1/2"	<b>48209</b>	N/A	N/A	<b>48209-W</b>	N/A
8 x 2"	<b>48210</b>	N/A	N/A	N/A	N/A

# CAULKS AND SEALANTS



▲ **100% Silicone Sealant- 11 Oz. Cartridge**  
**41702- White**  
**41701- Clear**



▲ **41200- Acrylic Latex Caulk- White- 11 Oz. Cartridge**



▲ **38070- Acrylic Caulk- Bright White- 5.5 Fl. Oz. Tube**

# PIPE CEMENTS



**30792**  
 ▲ **1/4 Pint All-Purpose Cement**

\*For ABS, PVC, CPVC, and styrene, all classes and schedules through 6" diameter. Fast setting.



▲ **85020- Butyl Tape- 30' Length- 1/8" Thick x 3/4" Wide**

\*Excellent, easy-to-use sealant, best available product for doors and windows.



▲ **85006- Electrical Tape- 60' Length x 3/4" Wide**

\*More of an insulator than a sealant, but we couldn't figure out the best place to put this item, so we made a spot for it here.

Sealants & Fasteners





## "TIE-DOWN" ANCHORS FOR SOIL, ROCK AND CONCRETE



▲ **10002- Galvanized Steel Single Disk Soil Anchor**  
 \*For softer soils, 3/4" rod, 60" length, single 7" helix. Use with frame tie and tension head bolt.

**10003- Soil Anchor- 36" Length with (1) 6" and (1) 4" Helix ▶**



### "EZ" Soil Anchor with Stabilizing Disc Attached

\*Combines the soil anchor and stabilizing plate into one simple step- 3/4" rod, 30" length, double 4" helix- stabilizing disc digs into ground with 4 cutting points. Reduces installation time.

**10013- with 7" x 1 5/8" Stabilizing Disc ▶**  
**10013-6CAP- with 6" x 1 1/8" Stabilizing Disc**



▲ **10007- Twin Disk Soil Anchor**  
 \*For clay and other hard soils, 3/4" rod, 30" length, double 4" helix.



◀ **10012- Stabilizer Plate for Loose Soil**



◀ **10025- Swivel Head Anchor Adapter**  
 \*Converts eye anchors into tension head anchors



◀ **10017 Rock Anchor Complete**  
 \*For use in hard/ rocky soil.



◀ **10016- Rock Anchor with Attached Plate Complete**  
 \*For use in hard/ rocky soil.



▲ **10019- Rock Anchor Rods Only**  
 \*Sold individually.



▲ **10005- J-Hook Anchor**  
 \*For use in wet concrete. Swivel head.



▼ **10018- Rock Anchor Head only**



▲ **10022 Patio Anchor Complete**  
 \*For dry concrete application.



▲ **10024- Patio Anchor Expansion Bolt only**



▲ **10014 Asphalt Anchor**

Set-Up/  
Transport

For tie-downs see page 79.  
 For tie-down tools, see page 84.





# "TIE-DOWN" ANCHOR TIES AND ACCESSORIES



◀ **Hook Frame Ties**  
\*Hooks to I-Beam under home.

- 10039- 6' Length    10042- 7' Length
- 10043- 8' Length    10044- 10' Length
- 10045- 12' Length    10049- 18' Length



◀ **10008- Split Bolt with Nut**  
\*8 per package. One of those staple items you just can't live without.

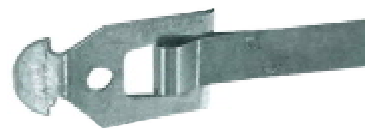

▲ **10047- 7' Universal Frame Tie**  
\*For use with I-beam hooks/brackets (10041 or 10041-4) or sidewall slotted buckle or nut/bolt connections.



▲ **10034- Xi2-24 Rim Joist Uplift Hook-Up Kit**  
\*Sold by the pair- For use with Xi2-24 Systems (see page 81)

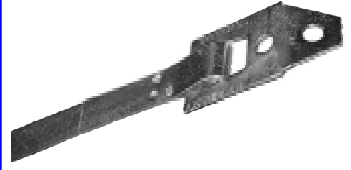

▲ **10046- 7' Corner Frame Tie**  
\*For diagonal use at perimeter corners, or marriage line anchors. Use with #10054 mounting bracket.



▲ **10011- Strap Protector Clip**  
\*For use between strap and I-Beam prevents cutting and breaking



▲ **Galvanized Steel Strapping**  
1 1/4" wide, marked and certified G-60  
10037- 37' Roll  
10038- 100# Roll  
\*Approximately 600' Long. (G-120 strap available upon request)



**Beam Clamp for #10046 Corner Tie**  
▲ 10054- 4-Bolt  
10055- 8-Bolt ▲  
Connects frame tie to bolt nearest anchor.



▲ **Clamp Hook for Tie Beam**  
10041- 3" Wide    10041-4- 4" Wide



▲ **10033- Strap Buckle**  
\*For splicing or extending 1 1/4" Galvanized Steel strap.

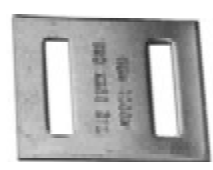

**Set-Up/Transport**



◀ **10340-A Swivel Tie Plate Assembly**



▲ **10015- Crimping Tool** ▲  
\*For crimping or splicing 1 1/4" steel strap. Use with #10010 strap seal.



◀ **10053 Angle Frame Bracket with Bolts and Nuts**



▲ **10040- Hook Only for Frame Tie**  
\*To be used with 1 1/4" Galvanized Steel Strap.



◀ **10035 Galvanized Steel Roof Bracket**



◀ **10010- Strap Seal**  
\*For crimping steel strap. Used to secure or extend existing lengths of galvanized strap.

For anchors see page 78.





# CLOSE-UP MATERIALS



## ◀ Close-Up/Transit Plastic Wrap- White

\*For use during mobile home or modular office transport. May also be used as a vapor barrier sheeting.

- 99099**- 14' x 300'- 4 mil thick
- 99085**- 14' x 300'- 6 mil thick
- 99088**- 16' x 300'- 6 mil thick



## White Close-Up Tape

- ◀ **85009**- 2" x 60 Yds.
  - 85010**- 4" x 60 Yds.
- \*This stuff is very sticky.



◀ **99968**- 1.25" x 800' Roll- Punched Steel Strap- High Tensile- Black \*29 gauge steel.

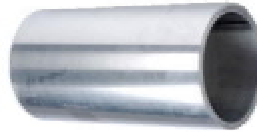

◀ **10599**- 10" x 50' Roll- Galvanized Steel Flashing \*28 gauge steel.

## Hex Lag Bolts



- 48303**- 3/8" x 3"    **48304**- 3/8" x 4"
- 48305**- 3/8" x 5"    **48306**- 3/8" x 6"
- 48308**- 3/8" x 8"

## Lag Bolt Washers



◀ **48309**- 3/8" x 1" (Small)  
\*100 per bag



▲ **48311**- 3/8" x 2" (Jumbo)  
\*100 per bag



▲ **99093**- Close-Up Zip Doors  
\*Sold per box of two. Can be used to make any size doorway on plastic sheeting, canvas or tarp.



▲ **99090**- 30" x 72" Zipper Access Hatch Door



◀ **85510**- "Husky" 32-Count Contractor Bags- Black- 42 Gallon

Set-Up/  
Transport





# "TIE-DOWN Xi2-24" FOUNDATION SYSTEMS

What is required for Singlewides up to 73' Length

(2) Xi2-24 Lateral Systems, (2) Xi2-24 Longitudinal Systems, 6 anchors, 6 universal frame ties, 6 tension split bolts with nuts, and 3 rim joist bracket kits.

For Singlewides 74' Length or more

(2) Xi2-24 Lateral Systems, (2) Xi2-24 Longitudinal Systems, 8 anchors, 8 universal frame ties, 8 tension split bolts with nuts, and 4 rim joist bracket kits.

For Doublewides up to 76' Length

(2) Xi2-24 Lateral Systems, (2) Xi2-24 Longitudinal Systems, 4 anchors, 4 universal frame ties, 4 tension split bolts with nuts, and 2 rim joist bracket kits.

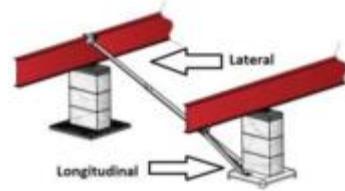

## ◀ 19831- Xi2-24 Lateral System for Soil

\*One system is comprised of one pad, one retractable lateral bar and hardware. Heavy galvanized coating on bracket and struts.



Very easy to install, even easier with tools!



Xi2-24 systems may also be used with steel piers.



## ◀ Xi2-24 Longitudinal System for Soil

\*Includes strut bar and hardware, works with each lateral system.

- 19895- 34" Length (2 block height)
- 19896- 43" Length (3 blocks)
- 19897- 48" Length (4 blocks)
- 19898- 57" Length (5 blocks)
- 19899- 69" Length (6 blocks)

◀ Use two longitudinal systems with one lateral systems for more strength! (optional)



## ◀ 19841- Xi2-24 Lateral System for Dry or Wet Concrete

\*One system is comprised of lateral strut and hardware. Heavy galvanized coating on bracket and struts.

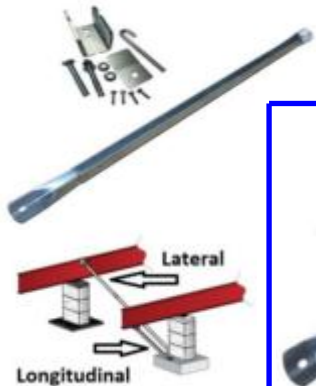

Longitudinal

## ◀ Xi2-24 Longitudinal System for Dry or Wet Concrete

\*Includes strut bar and hardware, works with each lateral system.

- 19890- 34" Length (2 block height)
- 19891- 43" Length (3 blocks)
- 19892- 48" Length (4 blocks)
- 19893- 57" Length (5 blocks)
- 19894- 69" Length (6 blocks)

## Optional Components for Xi-24 Systems

### ◀ 19885- Replacement Hardware Only for Xi2-24 Soil Lateral System

\*Sold separately just in case you need a spare set!



### ◀ 19875- Replacement Hardware Only for Xi2-24 Concrete Lateral System

\*Sold separately just in case you need a spare set!



### ▲ 19862- 7' Length Lateral Strut Only

\*For I-Beams spaced further apart (works for soil or concrete)



### ◀ 19886- Replacement Hardware Only for Xi2-24 Soil Longitudinal System

\*Sold separately just in case you need a spare set!



### ◀ 19876- Replacement Hardware Only for Xi2-24 Concrete Longitudinal System

\*Sold separately just in case you need a spare set!



▲ 19885- Double Beam Hardware Only for Xi2-24 Soil Lateral System Only

For anchors, see page 78.  
For tiedown items see page 79.





## "TIE-DOWN Xi2" FOUNDATION SYSTEMS FOR COMMERCIAL ASPHALT APPLICATION

Meets the requirements of the IBC 2018, 115 mph, Exposure C, ASCE 7-16, IRC Wind Loads- Easily and economically addresses both wind and seismic loads imposed on all 4 sides of the unit- Consists of Lateral and Longitudinal Stabilization and covers up to 32' width- For up to 12' wall height- Singlewides 16' wide max up to 58' Box- Use 2 Systems, 59'- 80' Use 3 Systems- Doublewides 32' wide max up to 40' box- 2 Systems, 41' to 64'- 3 Systems, 65'- 80', 4 Systems- Triple-wides 48' wide max up to 44' box- 3 Systems, 45'-62'- 4 Systems, 63'-78'- 5 Systems

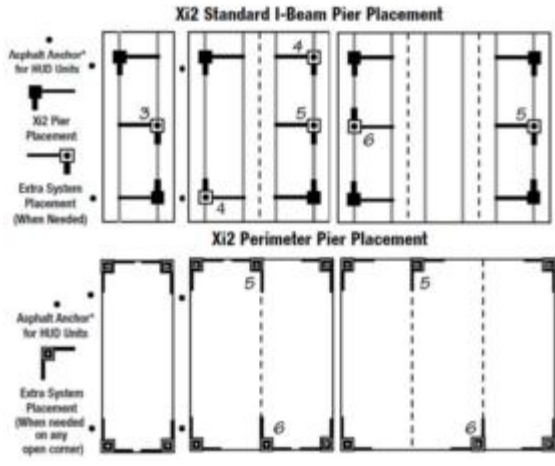

Use with 4 asphalt anchors (Page 78) on singlewides.



▲ **11030- Xi2 Base Bracket and Hardware for Asphalt using Concrete Blocks**  
\*One system is comprised of base bracket, three rods and hardware.



▲ **11031- Xi2 Base Bracket and Hardware for Asphalt using Steel Piers**  
\*One system is comprised of base bracket, three rods and hardware.



▲ **11032- 5' Lateral Bar for Concrete Xi2 System**  
\*Required to work with either asphalt base but sold separately! Only required for standard I-Beam framework.

### Longitudinal Strut Bar Only for Asphalt Systems ▶



\*Required to work with either asphalt base but sold separately!

- 11033-30- 30" Length
- 11033-39- 39" Length
- 11033-44- 44" Length
- 11033-53- 53" Length
- 11033-65- 65" Length

One of the following three longitudinal hardware kits is required, depending upon the type of undercarriage.

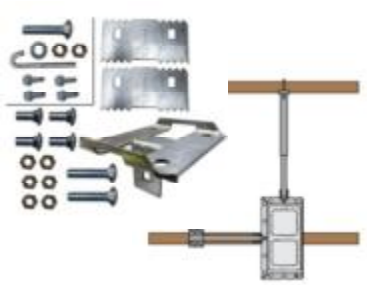

▲ **11034- Longitudinal Hardware for Standard I-Beam Frame**  
\*Required to work with either asphalt base but sold separately! For one lateral strut and one longitudinal bar.

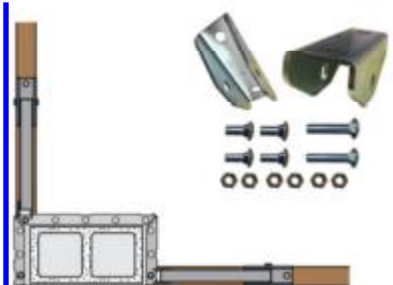

▲ **11035- Longitudinal Hardware for C-Beam Perimeter Frame**  
\*Required to work with either asphalt base but sold separately! For two longitudinal bars.

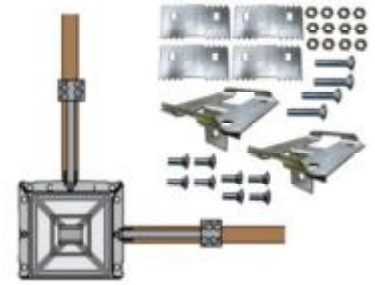

▲ **11037- Longitudinal Hardware for I-Beam Perimeter Frame**  
\*Required to work with either asphalt base but sold separately! For two longitudinal bars.

Set-Up/  
Transport





# SET-UP MATERIALS



◀ Vapor Barrier Plastic Sheetting  
6 mil thickness. Black. Smaller rolls for  
easy handling.

**99097- 16' x 100'**

**99096- 20' x 100'**



## Steel Piers ▲

\*Listed by nominal height.  
Pier head sold separately.

**12008- 8" 12010- 10"**

**12012- 12" 12014- 14"**

**12016- 16" 12018- 18"**

**12020- 20" 12022- 22"**

**12024- 24" 12026- 26"**

**12028- 28" 12030- 30"**

## Wood Blocks and Pads



**99918- 1" x 8" x 16"**

\*20 per bundle.

**99918-TR- 1" x 8" x 16"**

Pressure Treated.

\*20 per bundle.

**99928- 2" x 8" x 16"**

\*10 per bundle.

**99928-TR- 2" x 8" x 16"**

Pressure Treated.

\*10 per bundle.



◀ **12045**

Adjustable  
Head for  
Steel Pier  
Only



◀ **12046**

Adjustable  
Flat Head  
for Steel  
Pier Only



◀ **12047**

Adjustable  
Saddle  
Head for  
Steel Pier  
Only



◀ **12048**

Locking  
Head for  
Steel Pier  
Only

## ABS Pier Caps



**99918-ABS-**

**1" x 7.25" x 14.5"**

**99928-ABS-**

**2" x 7.25" x 14.5"**

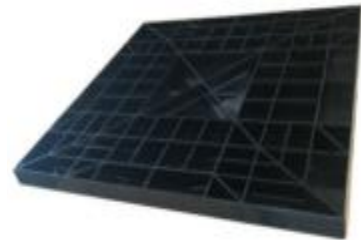

## ▲ ABS Foundation Pads

\*Lighter than concrete, saves on  
labor- Larger pads to increase  
spacing, saving time and material-  
Made from Recycled materials-  
Easily stackable for larger pad  
area and wider pier spacing-  
Approved for use by HUD  
3285.312(3).

**11610- 16" x 16" x .94"**

**11616- 16" x 18" x 7/8"**

**1162424- 24" x 24" x  
1.25"**

Set-Up/  
Transport

## Wedges



▲ **99930- 3" Wide Oak**



▲ **99937- 3.5" Wide  
Pressure Treated Pine**



▲ **99935-ABS- 3.5"  
Wide ABS Plastic**



▲ **99935- 4" Wide Oak**

For set-up tools, see next page.





# SET-UP AND ANCHORING TOOLS



## ▲ **Norco Hydraulic Jacks**

\*One year warranty

**10112**- 12 Ton/ Low

**10113**- 12 Ton/ Standard

**10120**- 22 Ton/ Low

**10121**- 22 Ton/ Standard



▲ **10050**- Electric Anchor Auger Drive Machine  
(20 RPM/ 120 V/ ½ HP) \*Bars and **10051** Adapter included.



▲ **10051**- Anchor Drive Adapter for #**10050** Machine



▲ **10051-EYE**- Eye Anchor Drive Adapter for #**10050** Machine



## Jacking Plates

\*Use with hydraulic jack.

**10135**- For 3.5" Wide I-Beam

**10150**- For 5" Wide I-Beam



◀ **10009**- Anchor Speed Wrench



\*For installing frame ties and tension head bolts- 15/16" socket on one side and a 15/16" nut on the other- for use with ratchet combined with 15/16" socket.



▲ **10366**- Roof Racking Alignment Tool (Sold per Pair)



▲ **10052**- Axle Removal Skid

Set-Up/  
Transport





## "TIE-DOWN" WHEEL, AXLE AND FRAME PARTS



◀ **11329**- Double Eye Cast Equalizer \*1.75" D.E., 9/16" holes, 5.6" overall



▲ **Spring Hangers**  
**11285**- 3.344" H x 2" W  
**11286**- 1.44" H x 1 3/4" W



▲ **10800**- Hitch Bolt \*3/4" Thread x 2" length- Grade 8 (ERB)- Use with **10801** nut.

**10802**- Hitch Bolt \*5/8" Thread x 2" length. Use with **10803** nut- Grade 8 (ERB)



▲ **11811**- Shackle Link  
 \*2 1/8" on center



▲ **10730**- Shackle Bolt- 9/16" x 3"  
**10737**- Nut Only for Shackle Bolt



◀ **110560**- Cotter Pin for Castle Nut



▲ **Bearings**  
**11058**- Outer Bearing 1 1/4"  
**11060**- Inner Bearing 1 3/8"



▲ **10736**- Rim Clamp Bolt- 1/2" x 13 x 1 5/8"- Coarse Thread



▲ **11512**- Rim Clamp "Keeper"

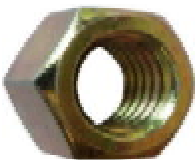

◀ **10801**- Nut Only for **10800** Hitch Bolt \*3/4" Thread- Grade 8 (ERB)  
**10803**- Nut Only for **10802** Hitch Bolt \*5/8" Thread- Grade 8 (ERB)



◀ **1146494**  
 Dust/ Grease Cap  
 1.25" depth-  
 2.375" ID



▲ **11094**  
 Grease Seal



▲ **110520**  
 Spindle Washer

Set-Up/  
 Transport

